

ALEXANDER INVARIANTS FOR VIRTUAL KNOTS

HANS U. BODEN, EMILY DIES, ANNE ISABEL GAUDREAU, ADAM GERLINGS, ERIC HARPER,
AND ANDREW J. NICAS

ABSTRACT. Given a virtual knot K , we introduce a new group-valued invariant VG_K called the virtual knot group, and we use the elementary ideals of VG_K to define invariants of K called the virtual Alexander invariants. For instance, associated to the 0-th ideal is a polynomial $H_K(s, t, q)$ in three variables which we call the virtual Alexander polynomial, and we show that it is closely related to the generalized Alexander polynomial $G_K(s, t)$ introduced in [40, 24, 42]. We define a natural normalization of the virtual Alexander polynomial and show it satisfies a skein formula. We also introduce the twisted virtual Alexander polynomial associated to a virtual knot K and a representation $\varrho: VG_K \rightarrow GL_n(R)$, and we define a normalization of the twisted virtual Alexander polynomial. As applications we derive bounds on the virtual crossing numbers of virtual knots from the virtual Alexander polynomial and twisted virtual Alexander polynomial.

INTRODUCTION

Given a virtual knot K , we define a finitely presented group, denoted VG_K , which we call the virtual knot group of K . Although the presentation of VG_K depends on the diagram of the virtual knot, we show that the group depends only on the virtual knot K . Thus VG_K is an invariant of the virtual knot K . The abelianization of VG_K is \mathbb{Z}^3 , the free abelian group on three generators, and we study the Alexander invariant associated to the surjection $VG_K \rightarrow \mathbb{Z}^3$. As an invariant of virtual knots, the Alexander invariant is quite useful in that it gives an obstruction to K being classical. For instance, we define the virtual Alexander polynomial $H_K(s, t, q) = \Delta_K^0(s, t, q)$, and if K is a classical knot, then it follows that $H_K(s, t, q)$ must vanish.

We establish a skein formula for the virtual Alexander polynomial and relate it to the generalized Alexander polynomial $G_K(s, t)$, which was defined by Sawollek [40], Kauffman and Radford [24], and Silver and Williams [42]. Proposition 3.8 and Corollary 4.8 show that (i) $G_K(s, t) = H_K(s, t, 1)$ up to units in $\mathbb{Z}[s^{\pm 1}, t^{\pm 1}]$, and (ii) $H_K(s, t, q) = G_K(sq^{-1}, tq)$ up to units in $\mathbb{Z}[s^{\pm 1}, t^{\pm 1}, q^{\pm 1}]$, and it follows that the virtual Alexander polynomial $H_K(s, t, q)$ determines the generalized Alexander polynomial $G_K(s, t)$ and vice versa.

The virtual polynomial $H_K(s, t, q)$ encodes information about the virtual crossing number $v(K)$, in particular the q -width of $H_K(s, t, q)$ gives a lower bound on $v(K)$. We give examples

Date: March 11, 2015.

2010 Mathematics Subject Classification. Primary: 57M25, Secondary: 57M27, 20C15.

Key words and phrases. Virtual knots and links, virtual knot groups, Alexander invariants, twisted Alexander polynomials, virtual crossing number.

to show that the bound on $v(K)$ obtained from $H_K(s, t, q)$ is sometimes stronger than the bound obtained from the arrow polynomial of Dye and Kauffman [8, 4]. For a virtual knot K expressed as the closure of a virtual braid β , the virtual Alexander invariant can be computed in terms of the virtual Burau representation $\Psi(\beta)$, and using this approach we show how to define the normalized virtual Alexander polynomial $\widehat{H}_K(s, t, q)$. In Theorem 5.6, we show that the normalized invariant $\widehat{H}_K(s, t, q)$ gives even stronger bounds on the virtual crossing number $v(K)$, and we present several examples where one obtains sharp results by applying this theorem.

Our approach to the virtual Alexander invariants is to define and compute them in terms of the virtual knot group VG_K , which is a new virtual knot invariant. Given any diagram of a virtual knot K , one can write down a presentation for VG_K in much the same way as is done for the classical knot group G_K . The generators of VG_K are given by all the short arcs of the diagram along with two auxiliary generators s and q . The generator s is used to relate adjacent arcs across over-crossings and the generator q is used to relate adjacent arcs across virtual crossings. In order to obtain invariance under the generalized Reidemeister moves, it is necessary that the variables s and q commute.

Although one can use biquandles (or virtual quandles) to define Alexander invariants of virtual knots (cf. [24] and [9]), there are several advantages to our approach. One is that the virtual Alexander invariants can be computed using any presentation of the virtual knot group VG_K . Another is that it provides a common framework for Alexander invariants of virtual knots and links, and one could use the same ideas to develop Alexander invariants for many of the other group-valued invariants of virtual and welded knots (cf. [2]). Finally, our approach can be also used to define twisted virtual Alexander invariants associated to representations $\varrho: VG_K \rightarrow GL_r(R)$ just as in the classical case.

Recall that twisted Alexander polynomials for knots in S^3 were first introduced by Lin [32] using free Seifert surfaces, and Wada then extended the definition to finitely presented groups using the Fox differential calculus in [47]. The resulting construction produces invariants of knots, links, and 3-manifolds that are remarkably strong and yet also highly computable. For instance, the twisted Alexander polynomials have been shown to detect the unknot and the unlink in [45, 12], and to detect fibered 3-manifolds in [1, 11]. The twisted Alexander polynomials have been applied to study slice knots [26, 15], periodic knots [16], and an interesting partial ordering on knots [30, 29, 17].

In Section 7, we extend the notion of twisted Alexander polynomials to virtual knots and links, addressing a question posed in [6], and we show that the resulting invariants often give stronger bounds on the virtual crossing number $v(K)$, see Theorem 7.8. In Section 8, we show how to compute the twisted invariants in terms of braids by using the twisted virtual Burau representation. In Section 9, we examine how the invariants change under the virtual Markov moves and define a preferred normalization of the twisted virtual Alexander polynomial that has less indeterminacy and gives an improved bound on the virtual crossing number, see Theorem 9.5.

Jeremy Green has classified virtual knots up to four crossings, and in this paper we will use his notation to refer to specific virtual knots in the table at [14].

1. A BRIEF INTRODUCTION TO VIRTUAL KNOTS

In this section we give a quick introduction to the theory of virtual knots.

Virtual knot theory was first introduced by Kauffman in [23]. There are several equivalent approaches, and we define an oriented virtual link to be an equivalence class of oriented virtual link diagrams. A virtual link diagram is an immersion of one or several circles in the plane with only double points, such that each double point is either classical (indicated by over- and under-crossings) or virtual (indicated by a circle). An oriented virtual link diagram is a virtual link diagram endowed with an orientation for each component, and two virtual link diagrams are said to be equivalent if they can be related by planar isotopies and a series of *generalized Reidemeister moves* $(r1)$ – $(r3)$ and $(v1)$ – $(v4)$ depicted in Figure 1. It was proved in [13] that if two classical knot diagrams are equivalent under the generalized Reidemeister moves, then they are equivalent under the classical Reidemeister moves, and consequently this shows that the theory of classical knots embeds into the theory of virtual knots.

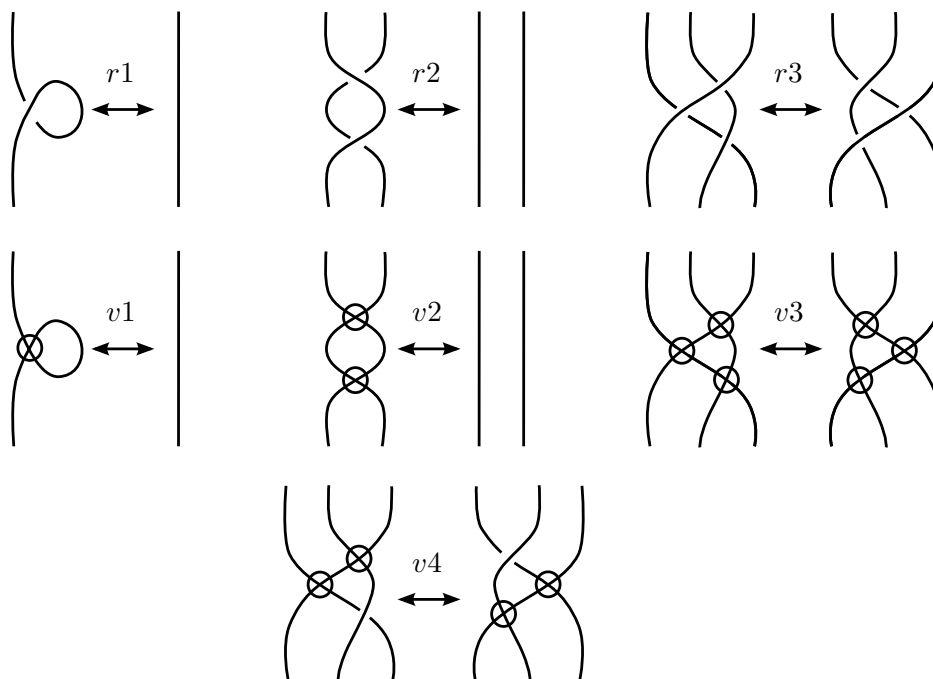

FIGURE 1. The generalized Reidemeister moves $(r1)$ – $(r3)$ and $(v1)$ – $(v4)$.

Virtual knots can also be described quite naturally as equivalence classes of Gauss diagrams. Given a knot K , its Gauss diagram consists of a circle, which represents points on K , along with directed chords from each over-crossing of K to the corresponding under-crossing. The chords are given a sign (\pm) according to whether the crossing is positive or negative. The Reidemeister moves can be translated into moves between Gauss diagrams, and in this way one can regard a classical knot as an equivalence class of Gauss diagrams.

Every classical knot corresponds to some Gauss diagram, but not all Gauss diagrams are associated with a classical knot. This deficiency disappears by passing to the larger category of virtual knots, which admit the alternative definition as equivalence classes of Gauss diagrams.

It is interesting that the Gauss diagram of a virtual knot does not explicitly indicate where to draw the virtual crossings; they are just a by-product of attempting to draw the virtual knot from its Gauss diagram. For this reason, it is often useful to ignore the virtual crossings for the purpose of defining invariants and indeed many invariants of classical knots can be extended to the virtual setting by means of this simple strategy. Notable examples include the Jones polynomial and the knot group G_K .

Virtual knots can be described geometrically as knots in thickened surfaces. Let Σ_g be an oriented surface of genus g and set $I = [0, 1]$, and consider a link $L \subset \Sigma_g \times I$. A diagram of L is obtained by projection onto a plane, keeping track of over- and under-crossings. In the case $g = 0$, there is essentially no loss of information in projecting, and this corresponds to the case of a classical link. However, if $g \geq 1$, then projecting L from the thickened surface to the plane may introduce additional self-intersections. These crossings correspond to virtual crossings, and in this way one obtains a virtual knot diagram from the projection of L to the plane.

In [5], the authors established a one-to-one correspondence between virtual links and stable equivalence classes of projections of links onto compact, oriented surfaces. (We refer the reader to [5] for the definition of stable equivalence.) Thus, the following result, which is due to Kuperberg [31], provides a geometric interpretation of virtual knots and links in terms of knots in thickened surfaces.

Theorem 1.1. *Every stable equivalence class of links in thickened surfaces has a unique irreducible representative.*

Using Kuperberg's theorem, we can define the genus $g(K)$ for any virtual knot K to be the genus of the surface of its unique irreducible representative. Obviously $g(K) = 0$ if and only if K is classical. Another closely related invariant of virtual knots is its virtual crossing number, which is defined as follows. Given a virtual knot or link diagram D , let $v(D)$ denote the number of virtual crossings of D . For a virtual knot or link K , the virtual crossing number $v(K)$ is defined to be the minimum of $v(D)$ over all diagrams D representing K . Clearly K is classical if and only if $v(K) = 0$. In general, we have the inequality $g(K) \leq v(K)$.

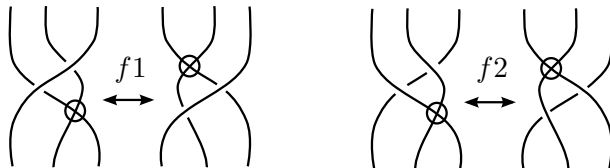

FIGURE 2. The two forbidden moves ($f1$) and ($f2$).

Two virtual knots or links are said to be *welded equivalent* if one can be obtained from the other by generalized Reidemeister moves plus the first forbidden move ($f1$) depicted in Figure 2. It was proved independently by Kanenobu and Nelson that by allowing both forbidden moves ($f1$) and ($f2$), every virtual knot diagram can be shown to be equivalent to the unknot [21, 35]. Allowing only the first forbidden move ($f1$), also called the forbidden overpass, leads to a nontrivial theory. A *welded knot* is an equivalence class of virtual knot diagrams under the moves ($r1$)–($r3$), ($v1$)–($v4$), and ($f1$). Given two virtual knots K_1 and K_2 , we write $K_1 \approx_w K_2$ if K_1 is welded equivalent to K_2 . In terms of Gauss diagrams, the first forbidden move corresponds to exchanging two adjacent arrow feet without changing their signs or arrowheads [34]. Therefore, a welded knot can also be viewed as an equivalence class of Gauss diagrams. In [38], it is proved that two classical knots are welded equivalent if and only if they are equivalent as classical knots, and this shows that the theory of classical knots embeds into the theory of welded knots.

Many invariants in knot theory extend in a natural way to virtual knots, including the Jones polynomial and the knot group G_K . Since it is central to many of our later constructions, we review the definition of G_K . Recall that for a classical knot $K \subset \mathbb{R}^3$, the knot group $G_K = \pi_1(\mathbb{R}^3 \setminus K, x_0)$ is the fundamental group of the complement of the knot, relative to some basepoint $x_0 \in \mathbb{R}^3$. The Wirtinger presentation for G_K , which depends on a diagram of K , has one generator for each arc and one relation for each crossing, depending on the sign of the crossing as indicated Figure 3.

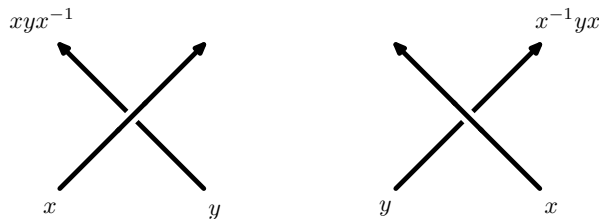

FIGURE 3. Relations in the knot group G_K at a classical crossing.

Even though virtual knots are not embeddings in \mathbb{R}^3 , one can apply the same procedure and associate to each virtual knot K an abstract group G_K . The group G_K has one generator for each *long arc*, which is an arc that starts and ends at under-crossings, and one relation for each classical crossing, just as in Figure 3. In this construction, one ignores the virtual crossings of K . The resulting group, denoted G_K , was first introduced by Kauffman in [23], and it is given by the (upper) Wirtinger presentation. If one regards K as a knot in the thickened surface $\Sigma_g \times I$, then G_K is the fundamental group of the complement of K in $\Sigma_g \times I / \sim$, where $x \sim y$ for all $x, y \in \Sigma_g \times \{0\}$; for a proof of this fact see [20, Proposition 5.1] by N. Kamada and S. Kamada. Using an analogous construction, one can define the *lower* Wirtinger presentation, and geometrically it is the fundamental group of the complement of K in $\Sigma_g \times I / \sim$, where $x \sim y$ for all $x, y \in \Sigma_g \times \{1\}$. It turns out that the lower group is the knot group of the knot obtained from K by changing all the classical crossings. For classical knots, the upper and lower presentations give the same group, but for virtual knots this is no longer true. The first example of this was provided in [13].

Example 1.2. If K is the knot depicted in Figure 4, then it has knot group $G_K \cong \mathbb{Z}$. This follows easily from the relation $b = bab^{-1}$ at the first crossing. Since K is a nontrivial virtual knot, this example shows that the knot group G_K does not detect the unknot among virtual knots. In the next section, we introduce the virtual knot group VG_K and show it is nontrivial for this knot.

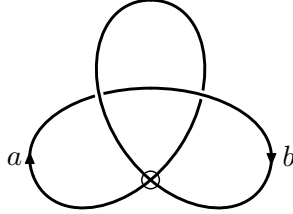

FIGURE 4. A virtual knot with trivial knot group.

The knot group does not change under applying the forbidden move $(f1)$, and thus G_K is an invariant of the welded equivalence class of K . That the knot in Example 1.2 is welded trivial can be seen quite easily by considering its Gauss diagram. This can also be established by applying moves $(r1)$ – $(r3)$, $(v1)$ – $(v4)$ and $(f1)$ to the virtual knot diagram in Figure 4, see [39, Example 2.1].

2. THE VIRTUAL KNOT GROUP

In this section we define the virtual knot group VG_K and show it is invariant under the generalized Reidemeister moves. We note that several authors have studied other group-valued invariants of virtual knots, and at the end of this section we present a commutative diamond relating VG_K to the extended group EG_K of Silver and Williams [44] and the quandle knot group QG_K of Manturov [33] and Bardakov and Bellingeri [2]. Note that all the groups surject to G_K , and note further that although some authors refer to G_K as the “virtual knot group”, we shall reserve that terminology exclusively for VG_K (cf. [41]).

Let K be a virtual knot or link represented by a virtual knot diagram. A *short arc* is an arc that begins from one virtual or classical crossing and terminates at the next one. In contrast to the classical knot group, short arcs terminate at under-crossings, over-crossings, and virtual crossings. The *virtual knot group* VG_K has one generator for each short arc, along with two additional generators s and q , and it has two relations for each crossing, depending on the sign of the crossing as indicated in Figure 5, along with the commutation relation $[s, q] = 1$.

We will see that VG_K is independent under the generalized Reidemeister moves, but before doing that, we present a simple example illustrating how to compute VG_K from a diagram for K .

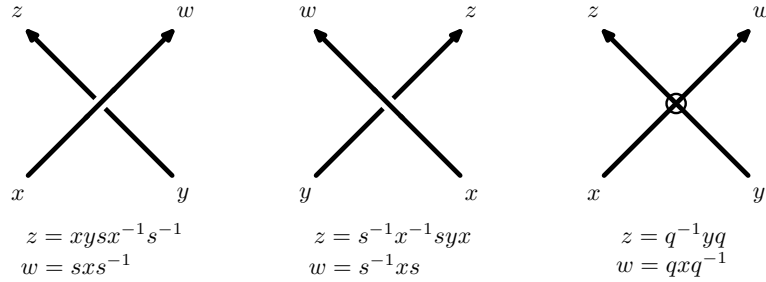

FIGURE 5

Example 2.1. We compute the virtual knot group for the knot depicted in Figure 6. Labeling the short arcs a, b, c, d, e, f as in Figure 6, we obtain the following presentation.

$$\begin{aligned}
 VG_K &= \langle a, b, c, d, e, f, s, q \mid [s, q] = 1, b = e^{-1}ad, c = s^{-1}bs, d = qcq^{-1}, \\
 &\quad e = s^{-1}ds, f = c^{-1}eb, a = q^{-1}fq \rangle \\
 &= \langle a, b, s, q \mid [s, q] = 1, a = q^{-1}s^{-1}b^{-1}qs^{-1}bs^2q^{-1}bq, \\
 &\quad b = qs^{-2}b^{-1}s^2q^{-1}aqs^{-1}bsq^{-1} \rangle, \\
 &= \langle b, s, q \mid [s, q] = 1, b = qs^{-2}b^{-1}sq^{-2}b^{-1}qs^{-1}bs^2q^{-1}bq^2s^{-1}bsq^{-1} \rangle.
 \end{aligned}$$

This group is nontrivial and can be used to show that K is nontrivial as a virtual knot, see Example 3.3.

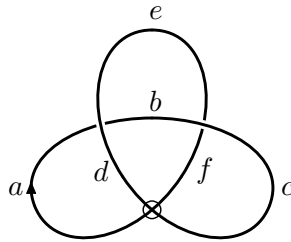
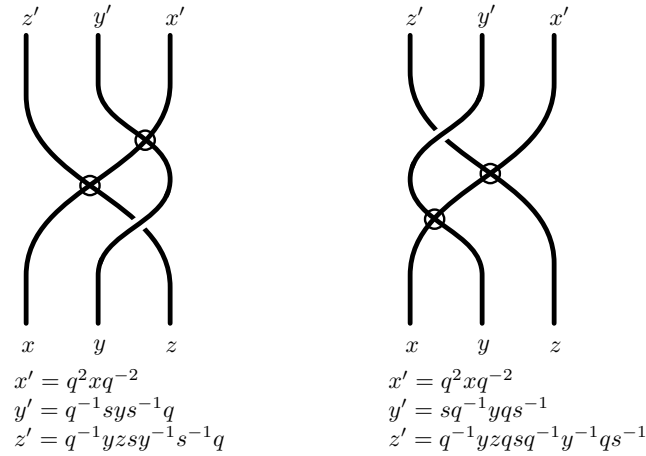

FIGURE 6. The virtual trefoil with labellings of the short arcs.

To verify that VG_K is an invariant of virtual knots, begin by considering the knot diagram of a virtual knot in a small neighborhood where the Reidemeister move is taking place. Label arcs according to the definition of VG_K , see Figure 5, and check to see that the knot diagram gives the same set of generators and relations before and after the move. As an example, we verify in Figure 7 that the mixed Reidemeister move $(v4)$ holds. The arcs are assumed to be oriented upwards in the figure, and note that the condition that s and q commute is necessary for invariance of $(v4)$. However, it's worth mentioning that the moves $(r1)$ – $(r3)$ and $(v1)$ – $(v3)$ are in fact invariant without this condition.

The virtual knot group VG_K has many interesting quotients. By setting $s = 1 = q$, we recover the classical knot group G_K as defined in the previous section. One can also show that after setting $s = q$, the forbidden move $(f1)$ holds. Thus the quotient of VG_K by the

FIGURE 7. Invariance of VG_K under (v4).

normal subgroup generated by qs^{-1} is invariant under welded equivalence, and the *welded knot group* is the quotient

$$WG_K = VG_K / \langle\langle qs^{-1} \rangle\rangle,$$

where $\langle\langle \cdot \rangle\rangle$ denotes the normal closure.

Example 2.2. The trivial knot \bigcirc has virtual and welded knot groups given by

$$\begin{aligned} VG_{\bigcirc} &= \langle a, s, q \mid [s, q] = 1 \rangle \cong \mathbb{Z} * \mathbb{Z}^2, \\ WG_{\bigcirc} &= \langle a, s \rangle \cong \mathbb{Z} * \mathbb{Z}. \end{aligned}$$

We say that K has trivial virtual knot group if $VG_K \cong \mathbb{Z} * \mathbb{Z}^2$, and that it has trivial welded knot group if $WG_K \cong \mathbb{Z} * \mathbb{Z}$. There exist nontrivial virtual knots with trivial virtual knot group, for example the Kishino knot depicted in Figure 8. (In [27], Kishino and Satoh use the 3-strand bracket polynomial to show this knot is nontrivial.) Therefore VG_K does not detect the trivial knot among virtual knots. It can be shown that $WG_K \cong G_K * \mathbb{Z}$. Hence WG_K and G_K carry the same information about K . It is an open problem whether G_K (equivalently, WG_K) detects the trivial knot among welded knots.

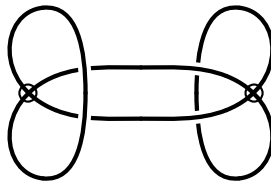

FIGURE 8. The Kishino knot has trivial virtual knot group, trivial Jones polynomial, and trivial generalized Alexander polynomial.

We now explain the relationships between the virtual knot group VG_K and various other groups that arise in virtual knot theory. For instance, under setting $q = 1$ in VG_K , one

obtains the extended group EG_K , which was introduced by Silver and Williams in [44], where it is denoted $\tilde{\pi}_K$. This group is related to the Alexander group, which Silver and Williams used to give a group-theoretic approach to the generalized Alexander polynomial, see [42] and [43].

By setting $s = 1$ in VG_K , one obtains the quandle knot group QG_K , which was introduced by Manturov [33] and by Bardakov and Bellingeri [2]. Finally, as we have already mentioned, if one sets $q = s$ in VG_K , one obtains the welded knot group WG_K . Each of these groups has the classical knot group G_K as a natural quotient, and the various relationships are summarized by the commutative diagram below.

Note that if K is a classical knot or link, then none of the relations in the Wirtinger presentation for VG_K involve q . Thus, no information is lost in setting $q = 1$, and this shows that VG_K is determined by the extended group EG_K . As we shall see in the next section, the same is true at the level of Alexander invariants, namely that for a classical knot or link K , the virtual Alexander invariants are determined by the classical Alexander invariants.

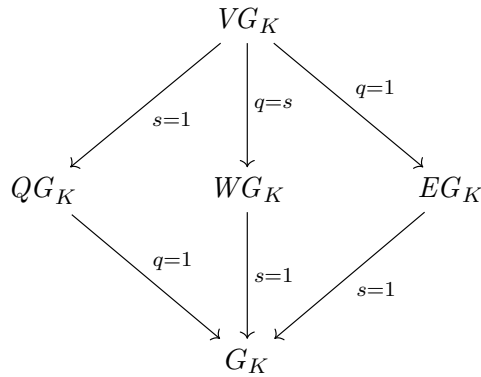

A commutative diamond representing the natural surjections between the virtual, quandle, welded, extended, and classical knot groups.

3. THE VIRTUAL ALEXANDER INVARIANT

In this section, we introduce the virtual Alexander invariants of a virtual knot K , and they are the Alexander invariants associated with the virtual knot group VG_K . Our approach is motivated by the case of classical knots, where one obtains powerful invariants of a knot K by studying the elementary ideal theory of the knot group G_K .

Given a virtual knot K , its virtual knot group VG_K has abelianization \mathbb{Z}^3 , and we use s, t, q to denote the three generators. Let VG'_K and VG''_K be first and second commutator subgroups of VG_K , and note that VG'_K is the kernel of $VG_K \rightarrow \mathbb{Z}^3$. The quotient VG'_K / VG''_K can be regarded as a module over the group-ring of \mathbb{Z}^3 , which is isomorphic to the ring of Laurent polynomials $\mathbb{Z}[s^{\pm 1}, t^{\pm 1}, q^{\pm 1}]$. We set $\mathcal{L} = \mathbb{Z}[s^{\pm 1}, t^{\pm 1}, q^{\pm 1}]$ and we refer to the module associated to the abelianization $VG_K \rightarrow \mathbb{Z}^3$ as the *virtual Alexander module*.

One can extract a number of invariants of the virtual knot K from its virtual Alexander module. For instance, if M is any $m \times n$ presentation matrix for the virtual Alexander module, then the ℓ -th elementary ideals \mathcal{E}_ℓ are defined as follows (see p. 101 of [7]). If $0 < n - \ell \leq m$, we define \mathcal{E}_ℓ to be the ideal of \mathcal{L} generated by all $(n - \ell) \times (n - \ell)$ minors of M , otherwise we set $\mathcal{E}_\ell = 0$ if $n - \ell > m$ and $\mathcal{E}_\ell = \mathcal{L}$ if $n - \ell \leq 0$. The elementary ideals are independent of the presentation matrix M , and they can be used to define invariants of the virtual knot K . However, the elementary ideals \mathcal{E}_ℓ are not generally principal, and so we shall instead consider ℓ -th principal elementary ideals \mathcal{I}_ℓ , which are defined to be the smallest principal ideals containing \mathcal{E}_ℓ . Thus \mathcal{I}_ℓ is generated by the gcd of the $(n - \ell) \times (n - \ell)$ minors of M . This is the basis for our definition of the virtual Alexander polynomial.

Definition 3.1. Given a virtual knot or link K , let Δ_K^ℓ be the Laurent polynomial given by the gcd of the $(n - \ell) \times (n - \ell)$ minors of M . It is a generator of the ℓ -th principal elementary ideal \mathcal{I}_ℓ , and it is well-defined up to units in \mathcal{L} , namely up to multiplication by $\pm s^i t^j q^k$ for $i, j, k \in \mathbb{Z}$. We call Δ_K^ℓ the ℓ -th virtual Alexander polynomial of K . The virtual Alexander polynomial Δ_K^0 will often be denoted $H_K(s, t, q)$.

We adopt notation to suppress the inherent indeterminacy of the virtual Alexander polynomial, namely we write $H_K(s, t, q) = f$ whenever $f \in \mathcal{L}$ is a Laurent polynomial such that $H_K(s, t, q) = \pm s^i t^j q^k \cdot f$ for some $i, j, k \in \mathbb{Z}$.

Remark 3.2. In Section 5 we will show that there is a normalization of the virtual Alexander polynomial to make it well-defined up to multiplication by $(st)^i$.

Example 3.3. Using the presentation for VG_K from Example 2.1, one can easily compute that the virtual Alexander polynomial for the virtual trefoil knot K is given by

$$\begin{aligned} H_K(s, t, q) &= s^{-1} + q^2 s^{-2} t + qt^2 - q^2 s^{-1} t^2 - t - qs^{-2} \\ &= s + q^2 t + qs^2 t^2 - q^2 st^2 - s^2 t - q \\ &= (s - q)(1 - st)(1 - qt). \end{aligned}$$

It is a basic fact that the elementary ideals are independent of the presentation matrix. Given any presentation

$$(1) \quad VG_K = \langle a_1, \dots, a_n, s, q \mid r_1, \dots, r_n, [s, q] \rangle,$$

one obtains a presentation matrix for the virtual Alexander module VG'_K / VG''_K by taking Fox derivatives of the relations in (1) with respect to the generators and substituting $a_i = t$ for $i = 1, \dots, n$. The resulting matrix is an $(n + 2) \times (n + 1)$ matrix of Laurent polynomials \mathcal{L} which we will denote by M . The 0-th elementary ideal \mathcal{E}_0 is the ideal generated by all $(n + 1) \times (n + 1)$ minors of M , and it is not necessarily principal. However, one can nevertheless compute the virtual Alexander polynomial entirely in terms of the virtual Alexander matrix A , which is the $n \times n$ Jacobian matrix

$$A = \left(\frac{\partial r_i}{\partial a_j} \Big|_{a_1, \dots, a_n = t} \right)$$

of Fox derivatives of the relations r_i with respect to the generators a_j . We take a moment to explain this rather delicate point here.

The virtual Alexander matrix A appears in the upper left hand corner of the presentation matrix M . To be specific, let $\left(\frac{\partial r}{\partial s}\right)$ and $\left(\frac{\partial r}{\partial q}\right)$ denote the column vectors of Fox derivatives of the relations r_1, \dots, r_n with respect to s and q , so $\left(\frac{\partial r}{\partial s}\right)$ has i -th entry equal to $\frac{\partial r_i}{\partial s} \Big|_{a_1, \dots, a_n=t}$ and $\left(\frac{\partial r}{\partial q}\right)$ has i -th entry equal to $\frac{\partial r_i}{\partial q} \Big|_{a_1, \dots, a_n=t}$. Then

$$M = \begin{bmatrix} A & \left(\frac{\partial r}{\partial s}\right) & \left(\frac{\partial r}{\partial q}\right) \\ \mathbf{0} & 1 - q & s - 1 \end{bmatrix},$$

where the last row is obtained by Fox differentiation of the commutator $[s, q]$.

Computing the $(n+1) \times (n+1)$ minors of M involves choosing one column to eliminate and taking the determinant. If either of the last two columns is chosen, one obtains minors equal to $(s-1) \det A$ and $(1-q) \det A$, respectively. If any one of the other columns is chosen, we claim that the resulting minor equals $\pm(t-1) \det A$.

The *fundamental identities* [10, (2.3)] for the Fox derivatives of the relators r_i are equations in the integral group-ring of the free group $F_{n+2} = \langle a_1, \dots, a_n, s, q \rangle$, namely

$$(2) \quad \sum_{j=1}^n \frac{\partial r_i}{\partial a_j} (a_j - 1) + \frac{\partial r_i}{\partial s} (s - 1) + \frac{\partial r_i}{\partial q} (q - 1) = r_i - 1, \quad i = 1, \dots, n.$$

Let A_j denote the j -th column of A . The map $a_i \mapsto t$, $s \mapsto s$ and $q \mapsto q$ extends to a ring homomorphism $\mathbb{Z}F_{n+2} \rightarrow \mathcal{L}$. Applying this homomorphism to (2) yields the following linear relation among the columns of M .

$$(3) \quad \sum_{j=1}^n A_j (t - 1) + \left(\frac{\partial r}{\partial s}\right) (s - 1) + \left(\frac{\partial r}{\partial q}\right) (q - 1) = \mathbf{0}.$$

Let \widehat{M}_k denote the result of removing the k -th column of M and let \widehat{A}_k denote the result of removing the k -th column of A . Then

$$\widehat{M}_k = \begin{bmatrix} \widehat{A}_k & \left(\frac{\partial r}{\partial s}\right) & \left(\frac{\partial r}{\partial q}\right) \\ \mathbf{0} & 1 - q & s - 1 \end{bmatrix}.$$

We calculate the determinant of \widehat{M}_k by expansion along its last row.

$$\begin{aligned} \det \widehat{M}_k &= -(1-q) \det \left[\widehat{A}_k \quad \left(\frac{\partial r}{\partial q}\right) \right] + (s-1) \det \left[\widehat{A}_k \quad \left(\frac{\partial r}{\partial s}\right) \right] \\ &= \det \left[\widehat{A}_k \quad (s-1) \left(\frac{\partial r}{\partial s}\right) + (q-1) \left(\frac{\partial r}{\partial q}\right) \right] \\ &= \det \left[\widehat{A}_k \quad \sum_{j=1}^n (1-t) A_j \right] \quad \text{by (3)} \\ &= \sum_{j=1}^n (1-t) \det \left[\widehat{A}_k \quad A_j \right] = (-1)^{n-k+1} (t-1) \det A. \end{aligned}$$

This shows that \mathcal{E}_0 is generated by $(s - 1) \det A$, $(t - 1) \det A$, and $(q - 1) \det A$. Since the ring $\mathcal{L} = \mathbb{Z}[s^{\pm 1}, t^{\pm 1}, q^{\pm 1}]$ of Laurent polynomials is a unique factorization domain, it is also a gcd domain, and consequently the principal generator of \mathcal{S}_0 is the gcd of the generators of \mathcal{E}_0 , which in this case one can see directly equals $\det A$. Thus it follows that $H_K(s, t, q) = \det A$.

A similar argument shows that the higher Alexander invariants Δ_K^ℓ are given by the gcd of the $(n - \ell) \times (n - \ell)$ minors of A .

Since the virtual Alexander polynomial $H_K(s, t, q)$ is only well-defined up to multiplication by $\pm s^i t^j q^k$, it is convenient to work with polynomials instead of Laurent polynomials, so we will often write $H_K(s, t, q)$ without negative powers of s, t, q by multiplying through by appropriate powers of s, t or q . We define the q -width of $H_K(s, t, q)$ to be the difference between the maximal q -degree and the minimal q -degree.

The next result shows that the q -width of $H_K(s, t, q)$ gives a lower bound on the virtual crossing number $v(K)$ of K which is defined in the introduction.

Theorem 3.4. *If K is a virtual knot or link and $H_K(s, t, q)$ is its virtual Alexander polynomial, then*

$$q\text{-width } H_K(s, t, q) \leq 2v(K).$$

Proof. Suppose D is a virtual knot diagram of K with $v(D) = m$. Then the virtual Alexander matrix has $2m$ rows with a q or q^{-1} entry. It follows that $\det A$ has q -width at most $2m$. \square

We give some examples to illustrate the utility of the bound on $v(K)$ coming from the virtual Alexander polynomial. In section 7, we will show how to improve these bounds using the twisted Alexander polynomial.

Example 3.5. Let K be the virtual knot depicted in Figure 9. An easy computation shows that

$$H_K(s, t, q) = (q^2 - s^2)(t^2 q^2 - 1)(st - 1).$$

Since $H_K(s, t, q)$ has q -width = 4, it follows that $v(K) \geq 2$. Comparing to Figure 9, we conclude that K has virtual crossing number 2.

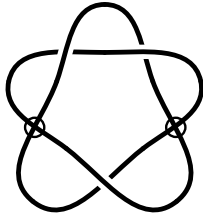

FIGURE 9. The virtual knot 3.7 has $v(K) = 2$.

Example 3.6. Let K be the virtual knot depicted in Figure 10. A straightforward computation shows that

$$H_K(s, t, q) = -(q^3t + q^2st + q^2 + 3qs + s^2)(tq - 1)(st - 1)(q - s).$$

Since $H_K(s, t, q)$ has q -width = 5, it follows that $v(K) \geq 3$. Comparing to Figure 10, we conclude that K has virtual crossing number 3.

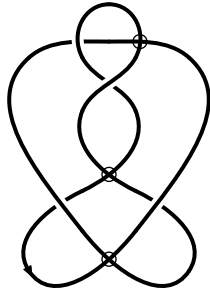

FIGURE 10. The virtual knot 4.62 has $v(K) = 3$.

The arrow polynomial of Dye and Kauffman [8] also gives an effective lower bound on the virtual crossing number $v(K)$, see for instance [4]. The following examples shows that the lower bound on $v(K)$ from $H_K(s, t, q)$ sometimes gives an improvement over that obtained from the arrow polynomial.

Example 3.7. According to [4], there are four virtual knots with 4 crossings having trivial arrow polynomial. They are the knots 4.46, 4.72, 4.98, and 4.107. Both 4.72 and 4.98 have $H_K(s, t, q) = 0$, but for the other two virtual knots, we use the virtual Alexander polynomial to get a lower bound on $v(K)$.

For $K = 4.46$, one computes that

$$H_K(s, t, q) = (q - s)(tq - 1)(st - 1)^2$$

and has q -width = 2. It follows that $v(K) \geq 1$. Thus $v(K) = 1$ or 2.

For $K = 4.107$, one computes that

$$H_K(s, t, q) = (q^2 - s^2)(t^2q^2 - 1)(st - 1)^2$$

and has q -width = 4. It follows that $v(K) \geq 2$. Thus $v(K) = 2$ or 3.

Next, we relate the virtual Alexander polynomial to the generalized Alexander polynomial defined by Sawollek [40], Kauffman–Radford [24], and Silver–Williams [42, 43]. Consider the presentation of VG_K obtained from the virtual knot diagram of K . This presentation has one meridional generator for each short arc and two relations for each crossing. The Alexander matrix one obtains from this presentation coincides, after setting $q = 1$, with the presentation matrix one gets from the Alexander biquandle. To see this, take the

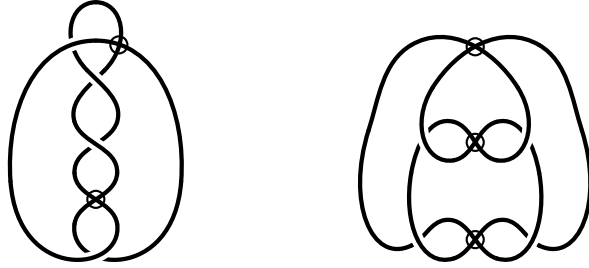

FIGURE 11. The virtual knots 4.46 (left) and 4.107 (right).

Fox derivatives of the relations coming from the right-handed crossing in Figure 5. Let $z = xysx^{-1}s^{-1}$ and $w = sxs^{-1}$, then

$$dw = \left(\frac{\partial w}{\partial x} \Big|_{x,y=t} \right) x + \left(\frac{\partial w}{\partial y} \Big|_{x,y=t} \right) y = sx$$

and

$$dz = \left(\frac{\partial z}{\partial x} \Big|_{x,y=t} \right) x + \left(\frac{\partial z}{\partial y} \Big|_{x,y=t} \right) y = (1-st)x + ty.$$

Similar formulas hold for left-handed crossings, and the resulting equations are identical to the ones coming from the Alexander biquandle, see [6, Definition 2.4].

The generalized Alexander polynomial $G_K(s, t)$ of a virtual knot or link is defined as the determinant of the presentation matrix of the Alexander biquandle, and together with the above observations, this immediately implies the following result.

Proposition 3.8. *For any virtual knot or link K , the generalized Alexander polynomial is determined by the virtual Alexander polynomial via the formula*

$$G_K(s, t) = H_K(s, t, 1).$$

If K is a classical knot or link, then it follows that the virtual Alexander polynomial vanishes. To see this, suppose K is a virtual knot with nonzero virtual Alexander polynomial. Then Proposition 4.10 implies that $H_K(s, t, q)$ has nonzero q -width, and Theorem 3.4 applies to show that $v(K) \geq 1$. Thus K is not classical.

For virtual knots or links K with trivial virtual Alexander polynomial, one can often use the virtual Alexander invariant to conclude that K is not classical (cf. [44, Corollary 4.8]). The idea is based on the observation that the virtual Alexander invariant of a classical knot is determined from the classical Alexander invariant under replacing t by st . Thus, if K is classical, then its $k = 1$ elementary ideal \mathcal{E}_1 must be principal with a generator that is symmetric under $s \leftrightarrow s^{-1}$ and $t \leftrightarrow t^{-1}$.

The next example illustrates this point for the virtual knots 4.99 and 4.105 depicted in Figure 12.

Example 3.9. Using the short arcs labelled a and b in Figure 12, we determine labels for all the other short arcs, and consequently we see can deduce presentations for the virtual knot groups VG_K with generators a, b, s, q .

For $K_1 = 4.99$, we find that

$$VG_{K_1} = \langle a, b, s, q \mid [s, q], absa^{-1}s^{-1}bsa^{-1}s^{-2}b^{-1}s \rangle.$$

Notice that the variable q does not appear in the last two relations. Taking the Fox derivatives, one can show that this knot has trivial virtual Alexander polynomial and that its $k = 1$ elementary ideal is given by $\mathcal{E}_1 = (1 - 2st)$. Although \mathcal{E}_1 is principal, the generator is not symmetric, and it follows that 4.99 is not classical.

We claim that the virtual knot group splits as a free product, $VG_{K_1} \cong G_{K_1} * \mathbb{Z}^2$. To see this, cyclically permute the relations and make the substitutions $x = sa, y = bs$. The new presentation of VG_{K_1} is given by

$$\begin{aligned} VG_{K_1} &= \langle x, y, s, q \mid [s, q], xyx^{-1}yx^{-1}y^{-1} \rangle \\ &\cong \langle x, y \mid xyx^{-1}yx^{-1}y^{-1} \rangle * \langle s, q \mid [s, q] \rangle. \end{aligned}$$

It is a simple exercise to check the first presentation yields the knot group G_{K_1} .

For $K_2 = 4.105$, we find that

$$\begin{aligned} VG_{K_2} = \langle a, b, s, q \mid [s, q], a^{-1}s^{-2}b^{-1}a^{-1}s^{-1}bs^2absa^{-1}s^{-2}b^{-1}sabs, \\ s^{-1}b^{-1}a^{-1}s^{-1}bsa^{-1}s^{-2}b^{-1}sabs^2as^{-1}b^{-1}sa \rangle. \end{aligned}$$

Notice that again the variable q does not appear in the last two relations. Taking the Fox derivatives, one can show that this knot has trivial virtual Alexander polynomial and that its $k = 1$ elementary ideal is given by $\mathcal{E}_1 = (2 - 2st + s^2t^2)$. Although \mathcal{E}_1 is principal, the generator is not symmetric, and it follows that 4.105 is not classical.

We claim that the virtual knot group splits as a free product, $VG_{K_2} \cong G_{K_2} * \mathbb{Z}^2$. To see this, substitute $x = sa, y = bs$. The new presentation of VG_{K_2} is given by

$$\begin{aligned} VG_{K_2} &= \langle x, y, s, q \mid [s, q], x^{-1}y^{-1}x^{-1}yxyx^{-1}y^{-1}xy, y^{-1}x^{-1}yx^{-1}y^{-1}xyxy^{-1}x \rangle \\ &\cong \langle x, y \mid x^{-1}y^{-1}x^{-1}yxyx^{-1}y^{-1}xy, y^{-1}x^{-1}yx^{-1}y^{-1}xyxy^{-1}x \rangle * \langle s, q \mid [s, q] \rangle. \end{aligned}$$

We leave it as an exercise to check that the first presentation yields the knot group G_{K_2} .

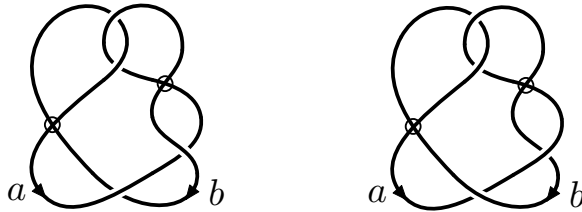

FIGURE 12. The virtual knots 4.99 (left) and 4.105 (right).

Remark 3.10. Both virtual knots in the previous example are *almost classical*. This means that they possess diagrams that admit *Alexander numberings* (see [44, Definition 4.3]). Alexander proved that every classical knot admits an Alexander numbering, thus every classical knot is almost classical. Furthermore, since a classical knot can be realized by a knot diagram without virtual crossings, it is evident that one can eliminate the variable q from the Wirtinger relations of VG_K . If the virtual knot K is almost classical, then by an Alexander numbering argument, it can be shown that $VG_K \cong G_K * \mathbb{Z}^2$.

4. THE VIRTUAL BRAID GROUP AND THE VIRTUAL BURAU REPRESENTATION

In this section, we introduce the virtual braid group and its Burau representation and show that they are closely related to the Alexander polynomial of a virtual knot or link obtained as a braid closure.

The *virtual braid group on k strands*, denoted VB_k , is the group is generated by symbols $\sigma_1, \dots, \sigma_{k-1}, \tau_1, \dots, \tau_{k-1}$ subject to the relations given below in (4), (5), (6). Here, σ_i represents a classical crossing and τ_i represents a virtual crossing involving the i -th and $(i+1)$ -th strands as in Figure 13. Virtual braids are drawn from top to bottom, and the group operation is given by stacking the diagrams, and the closure of a virtual braid represents a virtual link.

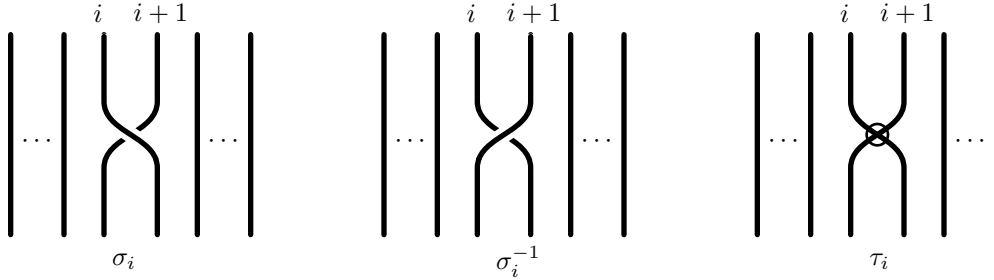

FIGURE 13. Generators of VB_k .

The relations in VB_k are given by three families of relations, the first involve only classical crossings σ_i and are the same as in classical braid group B_k , the second involve only virtual crossings τ_i and are the same as in the permutation group S_k , and the third are the mixed relations and involve both classical and virtual crossings:

$$(4) \quad \begin{aligned} \sigma_i \sigma_j &= \sigma_j \sigma_i && \text{if } |i - j| > 1, \\ \sigma_i \sigma_{i+1} \sigma_i &= \sigma_{i+1} \sigma_i \sigma_{i+1}, \end{aligned}$$

$$(5) \quad \begin{aligned} \tau_i \tau_j &= \tau_j \tau_i && \text{if } |i - j| > 1, \\ \tau_i \tau_{i+1} \tau_i &= \tau_{i+1} \tau_i \tau_{i+1}, \\ \tau_i^2 &= 1, \end{aligned}$$

$$(6) \quad \begin{aligned} \sigma_i \tau_j &= \tau_j \sigma_i && \text{if } |i - j| > 1, \\ \tau_i \sigma_{i+1} \tau_i &= \tau_{i+1} \sigma_i \tau_{i+1}. \end{aligned}$$

In Section 5, we will use Kamada's generalization of the Markov theorem to give a natural normalization for the virtual Alexander polynomial $H_K(s, t, q)$. This will be achieved by interpreting the virtual Alexander invariant in terms of the *virtual Burau representation*, introduced below in terms of a more general construction of the Magnus nonabelian 1-cocycle.

The fundamental representation of VB_k . Let $F_{k+2} = \langle x_1, \dots, x_k, s, q \rangle$ and let $\text{Aut}(F_{k+2} \text{ rel } \{s, q\})$ be the subgroup of $\text{Aut}(F_{k+2})$ consisting of those automorphisms of F_{k+2} that fix s and q . We view $\theta \in \text{Aut}(F_{k+2})$ as acting on the right on F_{k+2} so for $\theta_1, \theta_2 \in \text{Aut}(F_{k+2})$ the product $\theta_1\theta_2$ is left to right composition, that is, $(w)(\theta_1\theta_2) = ((w)\theta_1)\theta_2$.

For $i = 1, \dots, k-1$, define automorphisms $\Phi(\sigma_i), \Phi(\sigma_i^{-1})$ and $\Phi(\tau_i)$ of F_{k+2} fixing s and q as follows. For $j = 1, \dots, k$,

$$(7) \quad \begin{aligned} (x_j)\Phi(\sigma_i) &= \begin{cases} sx_{i+1}s^{-1} & \text{if } j = i, \\ x_{i+1}x_i(sx_{i+1}^{-1}s^{-1}) & \text{if } j = i+1, \\ x_j & \text{otherwise,} \end{cases} \\ (x_j)\Phi(\sigma_i^{-1}) &= \begin{cases} (s^{-1}x_i^{-1}s)x_{i+1}x_i & \text{if } j = i, \\ s^{-1}x_is & \text{if } j = i+1, \\ x_j & \text{otherwise,} \end{cases} \\ (x_j)\Phi(\tau_i) &= \begin{cases} qx_{i+1}q^{-1} & \text{if } j = i, \\ q^{-1}x_iq & \text{if } j = i+1, \\ x_j & \text{otherwise.} \end{cases} \end{aligned}$$

It is straightforward to show that this assignment of generators of VB_k to automorphisms of F_{k+2} respects the relations (4), (5), and (6). Hence Φ extends to a representation $\Phi: VB_k \rightarrow \text{Aut}(F_{k+2} \text{ rel } \{s, q\})$ that we call the *fundamental representation of the virtual braid group*. We will often suppress Φ and simply write x_i^β instead of $(x_i)\Phi(\beta)$.

Notice that under the fundamental representation, a virtual braid $\beta \in VB_k$ acts on x_1, \dots, x_k as depicted in Figure 14

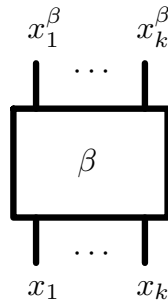

FIGURE 14. The braid automorphism β .

Notice further that if $K = \widehat{\beta}$ is the closure of $\beta \in VB_k$, then the virtual knot group VG_K admits the presentation

$$(8) \quad \langle x_1, \dots, x_k, s, q \mid x_1 = x_1^\beta, \dots, x_k = x_k^\beta, [s, q] = 1 \rangle.$$

For two virtual braids $\alpha, \beta \in VB_k$, the product $\alpha\beta$ acts on x_1, \dots, x_k as depicted in Figure 15.

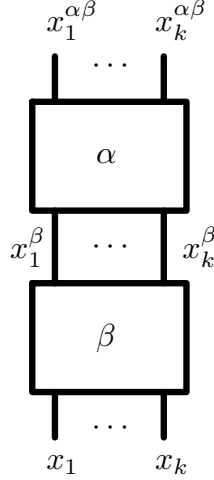

FIGURE 15. The composition $\alpha\beta$ of two braid automorphisms.

The Magnus non-abelian 1-cocycle. Given a matrix A over $\mathbb{Z}F_{k+2}$ and $\theta \in \text{Aut}(F_{k+2})$, let A^θ be the matrix obtained by applying θ to each entry of A (note that an automorphism of F_{k+2} extends to an automorphism of $\mathbb{Z}F_{k+2}$ denoted by the same symbol).

For $\theta_1, \theta_2 \in \text{Aut}(F_{k+2} \text{ rel } \{s, q\})$, the Chain Rule for Fox derivatives [10, (2.6)] yields

$$(9) \quad \frac{\partial}{\partial x_j} (x_i^{\theta_1})^{\theta_2} = \sum_{\ell=1}^k \left(\frac{\partial(x_i^{\theta_1})}{\partial x_\ell} \right)^{\theta_2} \frac{\partial(x_\ell^{\theta_2})}{\partial x_j}$$

(note that $\frac{\partial(s^{\theta_2})}{\partial x_j} = \frac{\partial s}{\partial x_j} = 0$ and $\frac{\partial(q^{\theta_2})}{\partial x_j} = \frac{\partial q}{\partial x_j} = 0$).

For $\theta \in \text{Aut}(F_{k+2} \text{ rel } \{s, q\})$ define the *Fox Jacobian* of θ with respect to the variables x_1, \dots, x_k to be the $k \times k$ matrix over $\mathbb{Z}F_{k+2}$ given by

$$D(\theta) = \left(\frac{\partial(x_i^\theta)}{\partial x_j} \right).$$

It follows from (9) that

$$(10) \quad D(\theta_1\theta_2) = D(\theta_1)^{\theta_2} D(\theta_2).$$

(Recall that $\theta_1\theta_2$ denotes left to right composition.) Applying (10) in the case $\theta_1 = \theta_2^{-1}$ shows that $D(\theta)$ is invertible for any $\theta \in \text{Aut}(F_{k+2} \text{ rel } \{s, q\})$. Hence the map

$D: \text{Aut}(F_{k+2} \text{ rel } \{s, q\}) \rightarrow GL_k(\mathbb{Z}F_{k+2})$ is a (right) non-abelian 1-cocycle that we call the *Magnus non-abelian 1-cocycle*.

The following properties of the Magnus non-abelian 1-cocycle are straightforward consequences of (10).

Proposition 4.1. (i) $D(\beta^{-1})^\beta = D(\beta)^{-1}$ for any $\beta \in \text{Aut}(F_{k+2} \text{ rel } \{s, q\})$.
(ii) $D(\gamma\beta\gamma^{-1})^\gamma = D(\gamma)^\beta D(\beta) D(\gamma)^{-1}$ for all $\beta, \gamma \in \text{Aut}(F_{k+2} \text{ rel } \{s, q\})$.

The virtual Burau representation. Let $\mathcal{L} = \mathbb{Z}[s^{\pm 1}, t^{\pm 1}, q^{\pm 1}]$ and let $\alpha: \mathbb{Z}F_{k+2} \rightarrow \mathcal{L}$ be the ring homomorphism determined by $\alpha(x_i) = t$, $\alpha(s) = s$ and $\alpha(q) = q$. Let $\alpha_*: GL_k(\mathbb{Z}F_{k+2}) \rightarrow GL_k(\mathcal{L})$ be the change of rings homomorphism, that is, $\alpha_*((a_{ij})) = (\alpha(a_{ij}))$ for $(a_{ij}) \in GL_k(\mathbb{Z}F_{k+2})$.

Definition 4.2. The *virtual Burau representation* is the map $\Psi: VB_k \rightarrow GL_k(\mathcal{L})$ given by $\Psi(\beta) = \alpha_*(D(\Phi(\beta)))$ for $\beta \in VB_k$.

The map $\Psi: VB_k \rightarrow GL_k(\mathcal{L})$ is a homomorphism: For $\beta, \gamma \in VB_k$,

$$\begin{aligned} \Psi(\beta\gamma) &= \alpha_*(D(\Phi(\beta\gamma))) = \alpha_*(D(\Phi(\beta)\Phi(\gamma))) \\ &= \alpha_*\left(D(\Phi(\beta))^{\Phi(\gamma)} D(\Phi(\gamma))\right) \quad \text{by (10)} \\ &= \alpha_*\left(D(\Phi(\beta))^{\Phi(\gamma)}\right) \alpha_*(D(\Phi(\gamma))) \end{aligned}$$

For any $w \in F_{k+2}$, $\alpha(w^\gamma) = \alpha(w)$ and thus $\alpha_*(D(\Phi(\beta))^{\Phi(\gamma)}) = \alpha_*(D(\Phi(\beta)))$. It follows that $\Psi(\beta\gamma) = \Psi(\beta)\Psi(\gamma)$.

By direct calculation, the images of the generators σ_i, σ_i^{-1} , and τ_i under the virtual Burau representation Ψ are given by the matrices

$$(11) \quad \begin{aligned} \Psi(\sigma_i) &= \begin{bmatrix} I_{i-1} & \cdots & \mathbf{0} \\ & 0 & s & \vdots \\ \vdots & t & 1-st & \\ \mathbf{0} & \cdots & & I_{k-i-1} \end{bmatrix}, \\ \Psi(\sigma_i^{-1}) &= \begin{bmatrix} I_{i-1} & \cdots & \mathbf{0} \\ & 1-s^{-1}t^{-1} & t^{-1} & \vdots \\ \vdots & s^{-1} & 0 & \\ \mathbf{0} & \cdots & & I_{k-i-1} \end{bmatrix}, \\ \Psi(\tau_i) &= \begin{bmatrix} I_{i-1} & \cdots & \mathbf{0} \\ & 0 & q & \vdots \\ \vdots & q^{-1} & 0 & \\ \mathbf{0} & \cdots & & I_{k-i-1} \end{bmatrix} \end{aligned}$$

where I_m is the $m \times m$ identity matrix.

The twisted virtual Burau representation. Let R be a commutative ring and let $\mathcal{L}_R = R[s^{\pm 1}, t^{\pm 1}, q^{\pm 1}]$ be the ring of Laurent polynomials over R . Let $\alpha: \mathbb{Z}F_{k+2} \rightarrow \mathcal{L}_R$ be the ring homomorphism determined by $\alpha(x_i) = t$, $\alpha(s) = s$ and $\alpha(q) = q$. Given any representation $\varrho: F_{k+2} \rightarrow GL_n(R)$, let $\tilde{\varrho} = \varrho \otimes \alpha: \mathbb{Z}F_{k+2} \rightarrow GL_n(\mathcal{L}_R)$. For any $k \times k$ matrix $A = (a_{ij})$ over $\mathbb{Z}F_{k+2}$, let $\tilde{\varrho}_*(A)$ be the block matrix obtained by replacing a_{ij} by $\tilde{\varrho}(a_{ij})$. We view $\tilde{\varrho}_*(A)$ as a $nk \times nk$ matrix over \mathcal{L}_R . This construction yields a homomorphism $\tilde{\varrho}_*: GL_k(\mathbb{Z}F_{k+2}) \rightarrow GL_{nk}(\mathcal{L}_R)$.

Definition 4.3. The ϱ -twisted virtual Burau representation is the map

$$\Psi_\varrho: VB_k \longrightarrow GL_{nk}(\mathcal{L}_R)$$

given by $\Psi_\varrho(\beta) = \tilde{\varrho}_*(D(\Phi(\beta)))$ for $\beta \in VB_k$.

In general, Ψ_ϱ is not a homomorphism of groups but rather has property (12) below. In the special case ϱ is the trivial representation, we recover the (untwisted) virtual Burau representation Ψ .

If θ is an automorphism of F_{k+2} then the composite $F_{k+2} \xrightarrow{\theta} F_{k+2} \xrightarrow{\varrho} GL_n(R)$ is also a representation that we denote by $\theta_*\varrho$. In the case of an automorphism of the form $\Phi(\beta)$, where $\beta \in VB_k$, we abbreviate $\Phi(\beta)_*\varrho$ by $\beta_*\varrho$. Note that $\widetilde{\beta_*\varrho} = \beta_*\tilde{\varrho}$. Since we view automorphisms of F_{k+2} as acting on the right, for $\beta, \gamma \in VB_k$ our convention gives $(\beta\gamma)_*\varrho = \beta_*(\gamma_*\varrho)$.

It follows from (10) that the map Ψ_ϱ has the property

$$(12) \quad \Psi_\varrho(\beta\gamma) = \Psi_{\gamma_*\varrho}(\beta) \Psi_\varrho(\gamma).$$

Iterating (12) yields

$$(13) \quad \Psi_\varrho(a_1 a_2 \cdots a_m) = \Psi_{(a_2 \cdots a_m)_*\varrho}(a_1) \Psi_{(a_3 \cdots a_m)_*\varrho}(a_2) \cdots \Psi_\varrho(a_m).$$

As a consequence of Proposition 4.1(ii), for $\beta, \gamma \in VB_k$ we have

$$(14) \quad \Psi_{\gamma_*\varrho}(\gamma\beta\gamma^{-1}) = \Psi_{\beta_*\varrho}(\gamma) \Psi_\varrho(\beta) \Psi_\varrho(\gamma)^{-1}.$$

The virtual Alexander invariants via braids. We now explain the relationship between the virtual Burau representation of $\beta \in VB_k$ and the Alexander polynomial $H_K(s, t, q)$ of the closure $K = \widehat{\beta}$. We will use this relationship to derive some interesting properties of $H_K(s, t, q)$.

Theorem 4.4. *Suppose $\beta \in VB_k$ is a virtual braid and $K = \widehat{\beta}$ is the virtual knot or link obtained from its closure. Then the ℓ -th virtual Alexander polynomial Δ_K^ℓ is given by the gcd of the $(k-\ell) \times (k-\ell)$ minors of the matrix $\Psi(\beta) - I_k$. In particular, the virtual Alexander polynomial is determined by the virtual Burau representation via the formula*

$$H_K(s, t, q) = \det(\Psi(\beta) - I_k).$$

Proof. Label the braid strands x_1, \dots, x_k and observe that labelling of braid strands according to the automorphisms given by σ_i, σ_i^{-1} , and τ_i is consistent with labelling according to

the relations of VG_K . As we use right automorphisms, the braid $\beta_1\beta_2$ corresponds to the left-to-right composition of automorphisms. The result is obtained by taking Fox derivatives of the relations in the presentation for VG_K in (8). \square

The next result, first proved by Bartholomew and Fenn [3, Theorem 7.1] (the case of the ‘‘Alexander switch’’), will be used to show that the generalized Alexander polynomial determines the virtual Alexander polynomial.

Theorem 4.5. *If K is a virtual knot or link, then the virtual Alexander polynomial satisfies*

$$H_K(s, t, q) = H_K(sq^{-1}, tq, 1).$$

Remark 4.6. Using the above identity and writing $H_K(s, t, q) = \sum_{ijk} a_{ijk} s^i t^j q^k$, it follows that $a_{ijk} = 0$ unless $i + k = j$. Thus, it follows that the virtual Alexander polynomial also satisfies

$$H_K(s, t, q) = H_K(1, st, qs^{-1}) = H_K(st, 1, qt).$$

Proof. Let $\beta \in VB_k$ be a virtual braid such that $K = \widehat{\beta}$. Write β as a product of generators $\beta = \theta_1 \cdots \theta_m$, where $\theta_j \in \{\sigma_i^{\pm 1}, \tau_i \mid 1 \leq i \leq k-1\}$. By Theorem 4.4, $H_K(s, t, q) = \det(\Psi(\beta) - I_k) = \det(\Psi(\theta_1) \cdots \Psi(\theta_m) - I_k)$. Let \mathbb{C}^* denote the multiplicative group of non-zero complex numbers. A $k \times k$ matrix A over $\mathbb{Z}[s^{\pm 1}, t^{\pm 1}, q^{\pm 1}]$ can be regarded as function from $(\mathbb{C}^*)^3$ to $k \times k$ matrices over \mathbb{C} via evaluation at the variables s, t, q and, when viewed as such, we write $A(s, t, q)$. Consider the diagonal $k \times k$ matrix

$$\Lambda = \begin{bmatrix} 1 & & & 0 \\ & q & & \\ & & \ddots & \\ 0 & & & q^{k-1} \end{bmatrix}.$$

A straightforward calculation yields:

$$\begin{aligned} (\Lambda \Psi(\sigma_i^{\pm 1}) \Lambda^{-1})(s, t, q) &= \Psi(\sigma_i^{\pm 1})(sq^{-1}, tq, 1) \quad \text{and} \\ (\Lambda \Psi(\tau_i) \Lambda^{-1})(s, t, q) &= \Psi(\tau_i)(1, 1, 1) = \Psi(\tau_i)(sq^{-1}, tq, 1). \end{aligned}$$

For the last equality, note that $\Psi(\tau_i)(s, t, q)$ is independent of s and t . Hence

$$\begin{aligned} H_K(s, t, q) &= \det(\Psi(\theta_1) \cdots \Psi(\theta_m) - I_n) = \det(\Lambda (\Psi(\theta_1) \cdots \Psi(\theta_m) - I_k) \Lambda^{-1}) \\ &= \det(\Lambda \Psi(\theta_1) \Lambda^{-1} \cdots \Lambda \Psi(\theta_m) \Lambda^{-1} - I_k) = H_K(sq^{-1}, tq, 1). \end{aligned}$$

\square

Theorem 4.7. *If K is a virtual knot or link, then the higher virtual Alexander invariants satisfy $\Delta_K^\ell(s, t, q) = \Delta_K^\ell(sq^{-1}, tq, 1)$ for all $0 \leq \ell < k$.*

By the same reasoning as in Remark 4.6, it follows that the higher virtual Alexander invariants also satisfy $\Delta_K^\ell(s, t, q) = \Delta_K^\ell(1, ts, qs^{-1}) = \Delta_K^\ell(st, 1, qt)$ for all $0 \leq \ell < k$.

Proof. We make use of the proof of Theorem 4.5 and the notation used there. Let $A = \Psi(\beta) - I_k$. Recall that $(\Lambda A \Lambda^{-1})(s, t, q) = A(sq^{-1}, tq, 1)$. For an $k \times k$ matrix B and an integer $0 \leq \ell < k$, let $\mathcal{E}_\ell(B)$ denote the ideal generated by the $(k - \ell) \times (k - \ell)$ minors of B , and let $\mathcal{I}_\ell(B)$ denote the smallest principal ideal containing $\mathcal{E}_\ell(B)$.

By [36, Theorem 2, §1.4], $\mathcal{E}_\ell(A) = \mathcal{E}_\ell(\Lambda A \Lambda^{-1})$ and hence $\mathcal{E}_\ell(A) = \mathcal{E}_\ell(A(sq^{-1}, tq, 1))$ (the right side of the last equality having the obvious meaning). It follows that we can choose generators f_1, \dots, f_m of $\mathcal{E}_\ell(A)$ satisfying $f_i(s, t, q) = f_i(sq^{-1}, tq, 1)$ for $1 \leq i \leq m$.

The higher Alexander invariant Δ_K^ℓ is given as the greatest common divisor of the set of generators of \mathcal{E}_ℓ , and it is well-defined up to units in the ring of Laurent polynomials. Thus, we have $\Delta_K^\ell = \gcd(f_1, \dots, f_m)$.

Since any irreducible factor in $\mathbb{Z}[s^{\pm 1}, t^{\pm 1}, q^{\pm 1}]$ of a polynomial of the form $f(sq^{-1}, tq)$ also has this form, it follows that Δ_K^ℓ satisfies the condition $\Delta_K^\ell(s, t, q) = \Delta_K^\ell(sq^{-1}, tq, 1)$. \square

The following corollary is a direct consequence of Proposition 3.8 and Theorem 4.5.

Corollary 4.8. *For any virtual knot or link K , the virtual Alexander polynomial is determined by the generalized Alexander polynomial via the formula*

$$H_K(s, t, q) = G_K(sq^{-1}, tq).$$

Lemma 4.9. *Let K be a virtual knot or link. Then $H_K(s, t, 1)$ is divisible by $1 - s$.*

Proof. Let A be an Alexander matrix for K and let A_1, \dots, A_n be the columns of A . Let B be the matrix obtained by replacing the first column of A with the left side of the relation (3). Then $\det(B) = 0$ and the linearity of the determinant as a function of the first column yields the identity

$$\det(A)(t - 1) + \det(A')(s - 1) + \det(A'')(q - 1) = 0,$$

where A' is obtained from A by replacing its first column with $\left(\frac{\partial r}{\partial s}\right)$ and A'' is obtained from A by replacing its first column with $\left(\frac{\partial r}{\partial q}\right)$. Evaluating at $q = 1$ gives

$$H_K(s, t, 1)(t - 1) = \det(A')|_{q=1} (1 - s),$$

and so $H_K(s, t, 1)$ is divisible by $1 - s$. \square

The next proposition shows that $H_K(s, t, q)$ is always divisible by $(q - s)(1 - qt)(1 - st)$ if K is a virtual knot.

Proposition 4.10. (i) *If K is a virtual knot or link then $H_K(s, t, q)$ is divisible by $q - s$.*
(ii) *If K is a virtual knot or link then $H_K(s, t, q)$ is divisible by $1 - tq$.*
(iii) *If K is a virtual knot then $H_K(s, t, q)$ is divisible by $1 - st$.*

Proof. Firstly, (i) is an immediate consequence of combining Theorem 4.5 and Lemma 4.9.

Secondly, by direct calculation, we see that for $1 \leq i \leq k-1$,

$$\begin{aligned} [t^{k-1}, \dots, t, 1] \Psi(\sigma_i)(s, t, t^{-1}) &= [t^{k-1}, \dots, t, 1] \quad \text{and} \\ [t^{k-1}, \dots, t, 1] \Psi(\tau_i)(s, t, t^{-1}) &= [t^{k-1}, \dots, t, 1]. \end{aligned}$$

Writing a given virtual braid $\beta \in VB_k$ as a word in the generators σ_i, τ_i , it follows that $[t^{k-1}, \dots, t, 1]$ is always a left eigenvector of $\Psi(\beta)(s, t, t^{-1})$ with eigenvalue $\lambda = 1$.

If K is a virtual knot or link, and $\beta \in VB_k$ is a braid with closure $\widehat{\beta} = K$, then $H_K(s, t, t^{-1}) = \det(\Psi(\beta)(s, t, t^{-1}) - I_k) = 0$ by Theorem 4.4. Thus $1 - qt$ is a factor of $H_K(s, t, q)$, and this shows (ii).

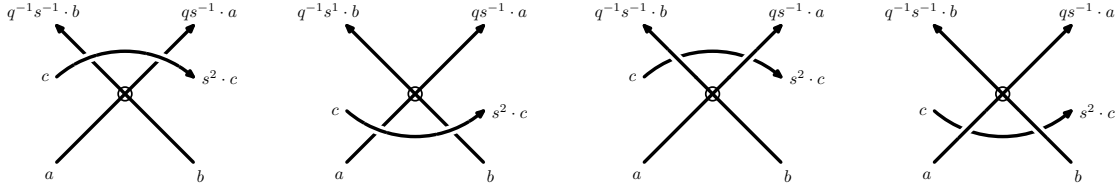

FIGURE 16. Invariance of $H_K(s, s^{-1}, q)$ under (f1) and (f2).

Thirdly, notice that $H_K(s, t, q)$ is invariant under (f1) and (f2), the first and second forbidden moves, upon setting $t = s^{-1}$. This can be seen using the diagrammatic argument depicted in Figure 16. From this it follows that $H_K(s, s^{-1}, q) = 0$ for any virtual knot K , because virtual knots can be unknotted using (f1) and (f2) (see [21, 35]). Thus if K is a virtual knot, then $1 - st$ is a factor of $H_K(s, t, q)$, and this gives (iii). Note that the same argument does not hold for virtual links, as it is not generally true that virtual links can be trivialized using (f1) and (f2). (In [37], Okabayashi gives a classification of virtual links up to forbidden moves.) \square

5. A NORMALIZATION FOR THE VIRTUAL ALEXANDER POLYNOMIAL

In this section, we give a natural normalization for the virtual Alexander polynomial $H_K(s, t, q)$ that is well defined up to multiplication by $(st)^i$. This is achieved by interpreting the virtual Alexander polynomial in terms of the virtual Burau representation (see Theorem 4.4). Key ingredients of the proof are the results of Kamada in [19, 22] giving virtual analogues of the Alexander and Markov theorems. The virtual Alexander theorem states that every virtual link is obtained as the closure of a virtual braid. The virtual Markov theorem, recalled below, gives necessary and sufficient conditions for two virtual braids $\beta \in VB_k$ and $\beta' \in VB_{k'}$ to represent the same virtual link.

Theorem 5.1 (Kamada [19]). *Two virtual braids have equivalent closures as virtual links if and only if they are related to each other by a sequence of the following VM1, VM2 and VM3 moves:*

VM1: a conjugation in the virtual braid group,

VM2: a positive, negative, or virtual right stabilization, and their inverse operations,

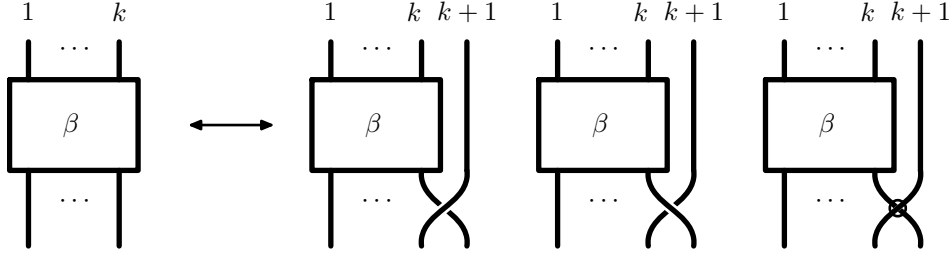

FIGURE 17. The right stabilization moves: positive, negative, virtual types.

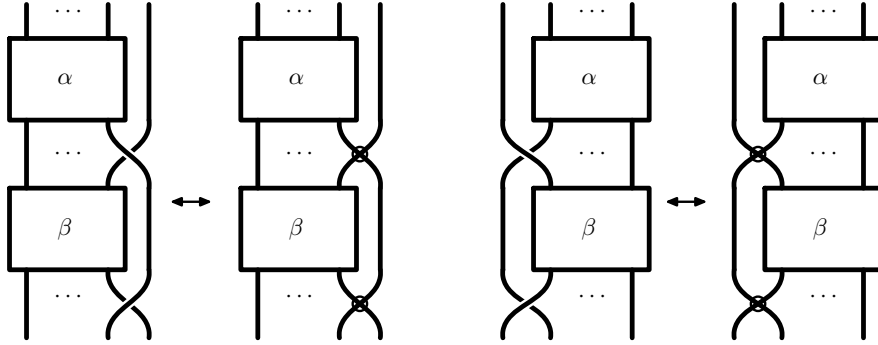

FIGURE 18. The right and left virtual exchange moves.

VM3: a right or left virtual exchange move.

Kamada showed that, unlike in the classical case, a virtual exchange move is not a consequence of the other moves, see [18].

Let $\mathcal{L} = \mathbb{Z}[s^{\pm 1}, t^{\pm 1}, q^{\pm 1}]$. We use the virtual Burau representation $\Psi: VB_k \rightarrow GL_k(\mathcal{L})$ (Definition 4.2) to define an invariant $H_\beta(s, t, q)$ of a virtual braid $\beta \in VB_k$ via the formula

$$H_\beta(s, t, q) = \det(\Psi(\beta) - I_k).$$

Note that Theorem 4.4 implies that if $K = \widehat{\beta}$ is the closure of β then $H_K(s, t, q) = H_\beta(s, t, q)$ up to units in \mathcal{L} .

The normalized virtual Alexander polynomial is obtained by studying the effect of the virtual Markov moves on $H_\beta(s, t, q)$.

We show that H_β is invariant under a VM1 move. For $\gamma \in VB_k$,

$$\begin{aligned} H_{\gamma\beta\gamma^{-1}}(s, t, q) &= \det(\Psi(\gamma\beta\gamma^{-1}) - I_k) = \det(\Psi(\gamma)\Psi(\beta)\Psi(\gamma)^{-1} - I_k) \\ &= \det(\Psi(\beta) - I_k) = H_\beta(s, t, q). \end{aligned}$$

Next, we examine how H_β changes under a VM2 move.

There is a natural injective stabilization homomorphism $\mu_k: VB_k \hookrightarrow VB_{k+1}$ given by taking the generators $\sigma_i, \tau_i, 1 \leq i \leq k-1$, of VB_k to the generators designated by the same symbols in VB_{k+1} . We write β for $\mu_k(\beta)$ when the meaning is clear from the context.

Proposition 5.2. *Let $\beta \in VB_k$. If β' is obtained from β by a right stabilization move of virtual type or of positive type then $H_{\beta'}(s, t, q) = -H_\beta(s, t, q)$. If β' is obtained from β by a right stabilization move of negative type then $H_{\beta'}(s, t, q) = -(st)H_\beta(s, t, q)$.*

Proof. Let $\Psi: VB_k \rightarrow GL_k(\mathcal{L})$ and $\Psi': VB_{k+1} \rightarrow GL_{k+1}(\mathcal{L})$ be the virtual Burau representations, and set $A = \Psi(\beta)$ and $A' = \Psi'(\beta')$. We consider separately the case of a virtual, positive, and negative stabilization.

Virtual stabilization. We have $\beta' = \beta\tau_k$. Thus, the matrices A and A' are related by:

$$A' = \Psi'(\beta\tau_k) = \Psi'(\beta)\Psi'(\tau_k) = \begin{bmatrix} A & \mathbf{0} \\ \mathbf{0} & 1 \end{bmatrix} \begin{bmatrix} I_{k-1} & \cdots & \mathbf{0} \\ \vdots & 0 & q \\ \mathbf{0} & q^{-1} & 0 \end{bmatrix}.$$

Let A_k denote the k -th column of A and let E be the elementary matrix

$$E = \begin{bmatrix} I_{k-1} & \cdots & \mathbf{0} \\ \vdots & 1 & 0 \\ \mathbf{0} & q^{-1} & 1 \end{bmatrix}.$$

Observe that

$$(A' - I_{k+1})E = \begin{bmatrix} A - I_k & A_k q \\ \mathbf{0} & -1 \end{bmatrix}.$$

Since $\det(E) = 1$, It follows that

$$\begin{aligned} H_{\beta'}(s, t, q) &= \det(A' - I_{k+1}) = \det((A' - I_{k+1})E) \\ &= \det\left(\begin{bmatrix} A - I_k & A_k q \\ \mathbf{0} & -1 \end{bmatrix}\right) = -\det(A - I_k) = -H_\beta(s, t, q). \end{aligned}$$

Positive stabilization. We have $\beta' = \beta\sigma_k^{-1}$. Thus the matrices A and A' are related by:

$$A' = \Psi'(\beta\sigma_k^{-1}) = \Psi'(\beta)\Psi'(\sigma_k^{-1}) = \begin{bmatrix} A & \mathbf{0} \\ \mathbf{0} & 1 \end{bmatrix} \begin{bmatrix} I_{k-1} & \cdots & \mathbf{0} \\ \vdots & 1 - s^{-1}t^{-1} & t^{-1} \\ \mathbf{0} & s^{-1} & 0 \end{bmatrix}.$$

Let A_k denote the k -th column of A and let E be the elementary matrix

$$E = \begin{bmatrix} I_{k-1} & \cdots & \mathbf{0} \\ \vdots & 1 & 0 \\ \mathbf{0} & s^{-1} & 1 \end{bmatrix}.$$

Observe that

$$(A' - I_{k+1})E = \begin{bmatrix} A - I_k & A_k t^{-1} \\ \mathbf{0} & -1 \end{bmatrix}.$$

Since $\det(E) = 1$, it follows that

$$\begin{aligned} H_{\beta'}(s, t, q) &= \det(A' - I_{k+1}) = \det((A' - I_{k+1})E) \\ &= \det\left(\begin{bmatrix} A - I_k & A_k t^{-1} \\ \mathbf{0} & -1 \end{bmatrix}\right) = -\det(A - I_k) = -H_{\beta}(s, t, q). \end{aligned}$$

Negative stabilization. We have $\beta' = \beta\sigma_k$. Thus, the matrices A and A' are related by:

$$A' = \Psi'(\beta\sigma_k) = \Psi'(\beta)\Psi'(\sigma_k) = \begin{bmatrix} A & \mathbf{0} \\ \mathbf{0} & 1 \end{bmatrix} \begin{bmatrix} I_{k-1} & \cdots & \mathbf{0} \\ \vdots & 0 & s \\ \mathbf{0} & t & 1 - st \end{bmatrix}.$$

Let A_k denote the k -th column of A and let E be the elementary matrix

$$E = \begin{bmatrix} I_{k-1} & \cdots & \mathbf{0} \\ \vdots & 1 & 0 \\ \mathbf{0} & s^{-1} & 1 \end{bmatrix}.$$

Observe that

$$(A' - I_{k+1})E = \begin{bmatrix} A - I_k & A_k s \\ \mathbf{0} & -st \end{bmatrix}.$$

Since $\det(E) = 1$, it follows that

$$\begin{aligned} H_{\beta'}(s, t, q) &= \det(A' - I_{k+1}) = \det((A' - I_{k+1})E) \\ &= \det\left(\begin{bmatrix} A - I_k & A_k s \\ \mathbf{0} & -st \end{bmatrix}\right) = -(st)\det(A - I_k) = -(st)H_{\beta}(s, t, q). \end{aligned}$$

□

Next, we show that H_{β} is unchanged by a VM3 move.

Proposition 5.3. *Let $\beta_1 \in VB_{k+1}$. If β_2 is obtained from β_1 by a right or a left exchange move then $H_{\beta_1}(s, t, q) = H_{\beta_2}(s, t, q)$.*

Proof. For α and β as in Figure 18, let $A = \Psi(\alpha)$ and $B = \Psi(\beta)$ (these are $k \times k$ matrices). We consider separately the cases of right and left virtual exchange moves.

Right virtual exchange move. Let

$$\begin{aligned} A' &= \begin{bmatrix} A & \mathbf{0} \\ \mathbf{0} & 1 \end{bmatrix}, & B' &= \begin{bmatrix} B & \mathbf{0} \\ \mathbf{0} & 1 \end{bmatrix}, \\ P &= \begin{bmatrix} I_{k-1} & \cdots & \mathbf{0} \\ \vdots & 0 & s \\ \mathbf{0} & t & 1 - st \end{bmatrix}, & Q &= \begin{bmatrix} I_{k-1} & \cdots & \mathbf{0} \\ \vdots & 0 & q \\ \mathbf{0} & q^{-1} & 0 \end{bmatrix}, \end{aligned}$$

$$E = \begin{bmatrix} I_{k-1} & \cdots & \mathbf{0} \\ \vdots & 1 & 0 \\ \mathbf{0} & -t + s^{-1} & t \end{bmatrix}, \quad F_1 = \begin{bmatrix} I_k & \mathbf{0} \\ \mathbf{0} & t \end{bmatrix}, \quad F_2 = \begin{bmatrix} I_k & \mathbf{0} \\ \mathbf{0} & q \end{bmatrix}.$$

Since $\beta_1 = \alpha\sigma_k\beta\sigma_k^{-1}$ and $\beta_2 = \alpha\tau_k\beta\tau_k$, we have

$$H_{\beta_1} = \det(A'PB'P^{-1} - I_{k+1}) \quad \text{and} \quad H_{\beta_2} = \det(A'QB'Q - I_{k+1}).$$

Consider the matrices

$$M_1 = F_1^{-1}(A'PB'P^{-1} - I_{k+1})E \quad \text{and} \quad M_2 = F_2(A'QB'Q - I_{k+1})F_2^{-1}.$$

Since $\det(E) = t = \det(F_1)$, it follows that $\det(M_1) = H_{\beta_1}$. Also, $\det(M_2) = H_{\beta_2}$.

Claim: $M_1 = M_2$.

Let A_k and B_k denote the k -th column of A and B , respectively, and let \widehat{A}_k and \widehat{B}_k be the $k \times (k-1)$ matrices obtained by removing the k -th column from A and B , respectively.

One easily finds that

$$\begin{aligned} (F_1^{-1}A')P &= \begin{bmatrix} A & \mathbf{0} \\ \mathbf{0} & t^{-1} \end{bmatrix} \begin{bmatrix} I_{k-1} & \cdots & \mathbf{0} \\ \vdots & 0 & s \\ \mathbf{0} & t & 1-st \end{bmatrix} = \begin{bmatrix} \widehat{A}_k & \mathbf{0} & A_k s \\ \mathbf{0} & 1 & t^{-1} - s \end{bmatrix} \quad \text{and} \\ B'(P^{-1}E) &= \begin{bmatrix} B & \mathbf{0} \\ \mathbf{0} & 1 \end{bmatrix} \begin{bmatrix} I_{k-1} & \cdots & \mathbf{0} \\ \vdots & 0 & 1 \\ \mathbf{0} & s^{-1} & 0 \end{bmatrix} = \begin{bmatrix} \widehat{B}_k & \mathbf{0} & B_k \\ \mathbf{0} & s^{-1} & 0 \end{bmatrix}. \end{aligned}$$

It follows that

$$\begin{aligned} (15) \quad M_1 &= F_1^{-1}A'P \cdot B'P^{-1}E - F_1^{-1}E \\ &= \begin{bmatrix} \widehat{A}_k & \mathbf{0} & A_k s \\ \mathbf{0} & 1 & t^{-1} - s \end{bmatrix} \begin{bmatrix} \widehat{B}_k & \mathbf{0} & B_k \\ \mathbf{0} & s^{-1} & 0 \end{bmatrix} - \begin{bmatrix} I_{k-1} & \cdots & \mathbf{0} \\ \vdots & 1 & 0 \\ \mathbf{0} & -1 + (st)^{-1} & 1 \end{bmatrix}. \end{aligned}$$

An easy computation shows that

$$\begin{aligned} B'(QF_2^{-1}) &= \begin{bmatrix} B & \mathbf{0} \\ \mathbf{0} & 1 \end{bmatrix} \begin{bmatrix} I_{k-1} & \cdots & \mathbf{0} \\ \vdots & 0 & 1 \\ \mathbf{0} & q^{-1} & 0 \end{bmatrix} = \begin{bmatrix} \widehat{B}_k & \mathbf{0} & B_k \\ \mathbf{0} & q^{-1} & 0 \end{bmatrix} \quad \text{and} \\ (F_2A')Q &= \begin{bmatrix} A & \mathbf{0} \\ \mathbf{0} & q \end{bmatrix} \begin{bmatrix} I_{k-1} & \cdots & \mathbf{0} \\ \vdots & 0 & q \\ \mathbf{0} & q^{-1} & 0 \end{bmatrix} = \begin{bmatrix} \widehat{A}_k & \mathbf{0} & A_k q \\ \mathbf{0} & 1 & 0 \end{bmatrix}. \end{aligned}$$

Hence

$$(16) \quad M_2 = \begin{bmatrix} \widehat{A}_k & \mathbf{0} & A_k q \\ \mathbf{0} & 1 & 0 \end{bmatrix} \begin{bmatrix} \widehat{B}_k & \mathbf{0} & B_k \\ \mathbf{0} & q^{-1} & 0 \end{bmatrix} - I_{k+1}.$$

The claim now follows by direct comparison of Equations (15) and (16), and this shows that $H_{\beta_1} = \det(M_1) = \det(M_2) = H_{\beta_2}$.

Left virtual exchange move. Let

$$A' = \begin{bmatrix} 1 & \mathbf{0} \\ \mathbf{0} & A \end{bmatrix}, \quad B' = \begin{bmatrix} 1 & \mathbf{0} \\ \mathbf{0} & B \end{bmatrix},$$

$$P = \begin{bmatrix} 0 & s & \mathbf{0} \\ t & 1 - st & \vdots \\ \mathbf{0} & \cdots & I_{k-1} \end{bmatrix}, \quad Q = \begin{bmatrix} 0 & q & \mathbf{0} \\ q^{-1} & 0 & \vdots \\ \mathbf{0} & \cdots & I_{k-1} \end{bmatrix},$$

$$E = \begin{bmatrix} t^{-1} & s - t^{-1} & \mathbf{0} \\ 0 & 1 & \vdots \\ \mathbf{0} & \cdots & I_{k-1} \end{bmatrix}, \quad F_1 = \begin{bmatrix} t & \mathbf{0} \\ \mathbf{0} & I_k \end{bmatrix}, \quad F_2 = \begin{bmatrix} q & \mathbf{0} \\ \mathbf{0} & I_k \end{bmatrix}.$$

Since $\beta_1 = \alpha\sigma_1\beta\sigma_1^{-1}$ and $\beta_2 = \alpha\tau_1\beta\tau_1$, we have

$$\begin{aligned} H_{\beta_1} &= \det(A'PB'P^{-1} - I_{k+1}) = \det(B'P^{-1}A'P - I_{k+1}) \quad \text{and} \\ H_{\beta_2} &= \det(A'QB'Q - I_{k+1}) = \det(B'QA'Q - I_{k+1}). \end{aligned}$$

(Note that $\det(XY - I_k) = \det(YX - I_k)$ for any $k \times k$ matrices X, Y over a commutative ring.)

Consider the matrices

$$M_1 = F_1 (B'P^{-1}A'P - I_{k+1}) E \quad \text{and} \quad M_2 = F_2^{-1} (B'QA'Q - I_{k+1}) F_2.$$

Since $\det(F_1) = t$ and $\det(E) = t^{-1}$, we have $\det(M_1) = H_{\beta}$. Also, $\det(M_2) = H_{\beta'}$. As in the case of the right exchange move, one can show that $M_1 = M_2$, and this implies that $H_{\beta_1}(s, t, q) = \det(M_1) = \det(M_2) = H_{\beta_2}(s, t, q)$. \square

We apply these results to define a preferred normalization for the virtual Alexander polynomial $H_K(s, t, q)$ as follows. Let K be a virtual knot or link represented as the closure of a braid $\beta \in VB_n$, and let $wr(\beta)$ be the writhe and $v(\beta)$ the virtual crossing number of closure $\widehat{\beta}$. Note that $v(\beta)$ depends on the braid word for β , whereas $wr(\beta)$ is invariant under the virtual braid relations (4), (5), and (6). In the definition below, we only need to correct by $(-1)^{wr(\beta)+v(\beta)}$, which can be easily calculated from the braid word for β and which depends only on $\beta \in VB_n$ and not on the braid word.

Definition 5.4. The *normalized virtual Alexander polynomial* is given by setting

$$\widehat{H}_K(s, t, q) = (-1)^{wr(\beta)+v(\beta)} H_\beta(s, t, q).$$

It is an invariant of virtual knots and links that is well-defined up to a factor of $(st)^i$.

Invariance follows from Theorem 5.1, Proposition 5.2 and Proposition 5.3, which show that $(-1)^{wr(\beta)+v(\beta)} H_\beta(s, t, q)$ is independent of braid representative, up to an overall factor of $(st)^i$.

Notice that $(-1)^{wr(\beta)+v(\beta)} = (-1)^{|\beta|}$, where $|\beta|$ denotes the length of β as a word in $\sigma_i, \sigma_i^{-1}, \tau_i$. As with $H_K(s, t, q)$, we will suppress the inherent indeterminacy of $\widehat{H}_K(s, t, q)$, namely we write $\widehat{H}_K(s, t, q) = f$ whenever $f \in \mathcal{L}$ is a Laurent polynomial such that $\widehat{H}_K(s, t, q) = (st)^i \cdot f$ for some $i \in \mathbb{Z}$.

The next result is proved in essentially the same way as Theorem 4.5, and details are left to the industrious reader.

Proposition 5.5. *If K is a virtual knot or link, then $\widehat{H}_K(s, t, q) = \widehat{H}_K(sq^{-1}, tq, 1)$.*

Using the normalized virtual Alexander polynomial, we obtain the following improvement of Theorem 3.4. We define \deg_q and $\deg_{q^{-1}}$ for the Laurent polynomial $\widehat{H}_K(s, t, q)$ by regarding it as a polynomial in q and q^{-1} .

Theorem 5.6. *Given a virtual knot or link K , then*

$$\deg_{q^{-1}} \widehat{H}_K(s, t, q) \leq v(K) \quad \text{and} \quad \deg_q \widehat{H}_K(s, t, q) \leq v(K).$$

We present two examples where one obtains sharp bounds on the virtual crossing numbers from the normalized Alexander polynomial. In both cases, these bounds are better than those obtained by the arrow polynomial or the unnormalized Alexander polynomial.

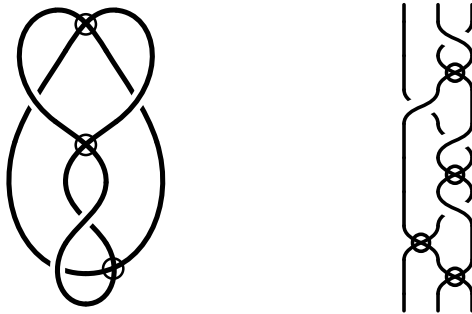

FIGURE 19. The virtual knot 4.42 has $v(K) = 3$ and is the closure of the virtual braid $\beta = \sigma_2 \tau_2 \sigma_1^{-1} \sigma_2^{-1} \tau_2 \sigma_2 \tau_1 \tau_2$.

Example 5.7. Let K be the virtual knot 4.42 depicted in Figure 19. Using the arrow polynomial, it has been shown that $v(K) \geq 2$, see [4]. On the other hand, using the fact

that K is the closure of the braid $\beta = \sigma_2\tau_2\sigma_1^{-1}\sigma_2^{-1}\tau_2\sigma_2\tau_1\tau_2 \in VB_3$, one can compute the normalized Alexander polynomial

$$\widehat{H}_K(s, t, q) = 1 - s^{-1}t^{-1} + (s^{-2}t^{-1} - s^{-1})q^1 + (s^{-1}t - t^2)q^2 + (s^{-1}t^2 - s^{-2}t)q^3.$$

Since $\deg_q \widehat{H}_K(s, t, q) = 3$, Theorem 5.6 implies that $v(K) = 3$.

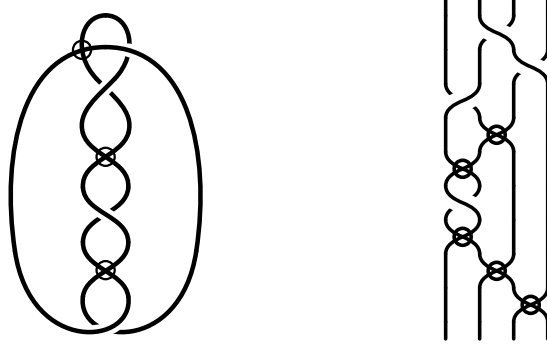

FIGURE 20. The virtual knot 4.45 has $v(K) = 3$ and is the closure of the virtual braid $\beta = \sigma_2\sigma_3\sigma_1^{-1}\tau_2\tau_1\sigma_1\tau_1\tau_2\tau_3$.

Example 5.8. Let K be the virtual knot 4.45 depicted in Figure 20. Using the arrow polynomial, it has been shown that $v(K) \geq 1$, see [4]. On the other hand, using the fact that K is the closure of the braid $\beta = \sigma_2\sigma_3\sigma_1^{-1}\tau_2\tau_1\sigma_1\tau_1\tau_2\tau_3 \in VB_4$, one can compute the normalized Alexander polynomial

$$\widehat{H}_K(s, t, q) = (s^2t - s^3t^2 + t^{-1} - s)q^{-1} + s^3t^3 - s^2t^2 - s^{-1}t^{-1} + 1 + (st^2 - t)q^1 + (s^{-1}t^2 - t^3)q^3.$$

Since $\deg_q \widehat{H}_K(s, t, q) = 3$, Theorem 5.6 implies that $v(K) = 3$.

6. A SKEIN FORMULA FOR THE VIRTUAL ALEXANDER POLYNOMIAL

In [40] and [24], a skein formula for the generalized Alexander polynomial $G_K(s, t)$ is established, and the goal of this section is to establish a skein formula for the virtual Alexander polynomial $H_K(s, t, q)$. This result is similar to the one obtained by Sawollek in [40], and we provide an independent and elementary proof. Throughout this section, to avoid the indeterminacy inherent in H_K and \widehat{H}_K , we will work with virtual knot and link diagrams.

To begin, we give a formula for expanding the determinant of an $n \times n$ matrix along the first two rows, following the well-known principle of multi-row Laplace expansion.

Suppose A is an $n \times n$ matrix given by

$$A = \begin{bmatrix} a_1 & a_2 & \cdots & a_n \\ b_1 & b_2 & \cdots & b_n \\ & & P & \end{bmatrix},$$

where $P = (p_{ij})$ is an $(n-2) \times n$ matrix.

By multi-row Laplace expansion along the first and second rows of A ,

$$(17) \quad \det A = \sum_{i=1}^{n-1} \sum_{j=i+1}^n (-1)^{i+j-1} (a_i b_j - a_j b_i) \det(\widehat{P}_{ij}).$$

In this formula, \widehat{P}_{ij} denotes the square $(n-2) \times (n-2)$ matrix obtained by removing the i -th and j -th columns from P .

Now suppose K_+ , K_- , and K_0 are three oriented virtual knot or link diagrams which are identical everywhere except near one crossing, where K_+ has a positive crossing, K_- has a negative crossing, and K_0 has the crossing removed, see Figure 21.

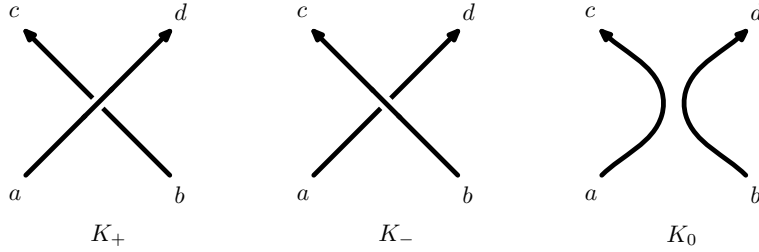

FIGURE 21. The skein triple K_+ , K_- and K_0 .

Label the short arcs of K_+ so that at the crossing in question, the arcs are as in Figure 21, namely a for the incoming over-crossing, b for the incoming under-crossing, c for the outgoing under-crossing and d for the outgoing over-crossing and likewise for K_- and K_0 .

Thus,

$$\begin{aligned} H_{K_+}(s, t, q) &= \det \begin{bmatrix} 1 - st & t & -1 & 0 & 0 & \cdots & 0 \\ s & 0 & 0 & -1 & 0 & \cdots & 0 \\ & & & P & & & \end{bmatrix}, \\ H_{K_-}(s, t, q) &= \det \begin{bmatrix} 0 & s^{-1} & -1 & 0 & 0 & \cdots & 0 \\ t^{-1} & 1 - (st)^{-1} & 0 & -1 & 0 & \cdots & 0 \\ & & & P & & & \end{bmatrix}, \\ H_{K_0}(s, t, q) &= \det \begin{bmatrix} 1 & 0 & -1 & 0 & 0 & \cdots & 0 \\ 0 & 1 & 0 & -1 & 0 & \cdots & 0 \\ & & & P & & & \end{bmatrix}. \end{aligned}$$

Applying formula (17) to $H_{K_+}(s, t, q)$ and $H_{K_-}(s, t, q)$, we get that

$$\begin{aligned} H_{K_+}(s, t, q) &= -st\widehat{P}_{12} - s\widehat{P}_{13} - (1-st)\widehat{P}_{14} + t\widehat{P}_{24} + \widehat{P}_{34} \\ H_{K_-}(s, t, q) &= -(st)^{-1}\widehat{P}_{12} - t^{-1}\widehat{P}_{13} + (1-(st)^{-1})\widehat{P}_{23} + s^{-1}\widehat{P}_{24} + \widehat{P}_{34} \end{aligned}$$

Thus,

$$\begin{aligned} H_{K_+} - (st)H_{K_-} &= (1 - st)\widehat{P}_{12} + (st - 1)\widehat{P}_{14} + (1 - st)\widehat{P}_{23} + (1 - st)\widehat{P}_{34} \\ &= (1 - st)\left(\widehat{P}_{12} - \widehat{P}_{14} + \widehat{P}_{23} + \widehat{P}_{34}\right). \end{aligned}$$

On the other hand, expanding $H_{K_0}(s, t, q)$ along the first two rows reveals that

$$H_{K_0}(s, t, q) = \widehat{P}_{12} - \widehat{P}_{14} + \widehat{P}_{23} + \widehat{P}_{34},$$

and it follows that

$$H_{K_+} - (st)H_{K_-} = (1 - st)H_{K_0}.$$

Since the entire calculation can be performed on three braids $\beta_+, \beta_-, \beta_0$ that are identical everywhere outside of one crossing, this argument applies equally well to the normalized invariant of Definition 5.4. One only needs to note that the virtual crossing number and writhe satisfy $v(\beta_+) = v(\beta_-) = v(\beta_0)$ and $wr(\beta_+) = wr(\beta_-) + 2 = wr(\beta_0) + 1$. This causes a sign change in the coefficient of \widehat{H}_{β_0} , and the following theorem summarizes our discussion.

Theorem 6.1. *Let K_+, K_- , and K_0 be three oriented virtual knot or link diagrams obtained from the closures of braids β_+, β_- , and β_0 , respectively, which are identical everywhere except near one crossing, where they are as pictured in Figure 21. Then the normalized virtual Alexander polynomial satisfies the skein formula*

$$\widehat{H}_{K_+}(s, t, q) - (st)\widehat{H}_{K_-}(s, t, q) = (st - 1)\widehat{H}_{K_0}(s, t, q).$$

Note that in the above formula, there is no indeterminacy in $\widehat{H}_{K_+}, \widehat{H}_{K_-}$, and \widehat{H}_{K_0} since they are all computed with respect to a given virtual knot or link diagram.

7. TWISTED ALEXANDER INVARIANTS FOR VIRTUAL KNOTS

In this section, we introduce twisted versions of virtual Alexander invariants for virtual knots and links. We begin by recalling the definition of the twisted Alexander polynomial for finitely presented groups from [47].

Given a group Γ with presentation $P = \langle a_1, \dots, a_k \mid r_1, \dots, r_\ell \rangle$, a surjection $\alpha: \Gamma \rightarrow \mathbb{Z}^s$, and a representation $\varrho: \Gamma \rightarrow GL_n(R)$, where R is a unique factorization domain, we will construct the twisted Alexander polynomial $\Delta_{\Gamma, \alpha}^{\varrho}(t_1, \dots, t_s)$. Let F_k denote the free group of rank k . The presentation P determines a surjection $\varphi: F_k \rightarrow \Gamma$, which induces a ring homomorphism $\tilde{\varphi}: \mathbb{Z}F_k \rightarrow \mathbb{Z}\Gamma$ on the integral group-rings. Likewise, the surjection $\alpha: \Gamma \rightarrow \mathbb{Z}^s$ induces a ring homomorphism $\tilde{\alpha}: \mathbb{Z}\Gamma \rightarrow \mathbb{Z}[t_1^{\pm 1}, \dots, t_s^{\pm 1}]$, the integral group-ring of \mathbb{Z}^s ; and the representation $\varrho: \Gamma \rightarrow GL_n(R)$ induces a ring homomorphism $\tilde{\varrho}: \mathbb{Z}\Gamma \rightarrow M_n(R)$, the algebra of $n \times n$ matrices over R .

Let $\mathcal{L}_R = R[t_1^{\pm 1}, \dots, t_s^{\pm 1}]$ be the ring of Laurent polynomials with coefficients in R . The Jacobian of the presentation P is the $\ell \times k$ matrix $J = \left(\frac{\partial r_i}{\partial a_j}\right)$. Let

$$\Omega = (\tilde{\varrho} \otimes \tilde{\alpha}) \circ \tilde{\varphi}: \mathbb{Z}F_k \rightarrow M_n(\mathcal{L}_R)$$

be the composition of $\tilde{\varphi}: \mathbb{Z}F_k \rightarrow \mathbb{Z}\Gamma$ with the tensor product $\tilde{\varrho} \otimes \tilde{\alpha}: \mathbb{Z}\Gamma \rightarrow M_n(\mathcal{L}_R)$. The twisted presentation matrix $M = \Omega\left(\frac{\partial r_i}{\partial a_j}\right)$ is an $\ell \times k$ matrix with entries in $M_n(\mathcal{L}_R)$, that is, a block matrix.

Remark 7.1. If $\sum m_i w_i \in \mathbb{Z}\Gamma$, where $m_i \in \mathbb{Z}$ and $w_i \in \Gamma$, then

$$\tilde{\varrho} \otimes \tilde{\alpha}\left(\sum m_i w_i\right) = \sum m_i \varrho(w_i) \cdot \alpha(w_i)$$

where $\alpha(w_i)$ acts by scalar multiplication on $\varrho(w_i)$.

Let \widehat{M}_j denote the matrix obtained by removing the j -th column from M , and we can regard \widehat{M}_j as an $n\ell \times n(k-1)$ matrix with entries in \mathcal{L}_R . If $\ell < k-1$, then \widehat{M}_j has more columns than rows, and its determinant is zero. If $\ell > k-1$, then \widehat{M}_j has more rows than columns, and then we consider multi-indices I of length $|I| = n(k-1)$ and use \widehat{M}_j^I to denote the square matrix consisting of the I rows from \widehat{M}_j .

The following result is essential to the construction of the twisted Alexander polynomials, and it is proved in [47, Lemmas 2 and 3].

Lemma 7.2. (i) For some a_j , $\det(\Omega(1 - a_j))$ is nonzero.

(ii) If $\det(\Omega(1 - a_j))$ and $\det(\Omega(1 - a_k))$ are both nonzero, then for any multi-index I of length $|I| = n(k-1)$,

$$\det(\widehat{M}_j^I) \det(\Omega(1 - a_k)) = \pm \det(\widehat{M}_k^I) \det(\Omega(1 - a_j)).$$

The sign in the above formula is always positive if the representation ϱ has even degree.

We consider the set of determinants $\{\det(\widehat{M}_j^I) \mid |I| = n(k-1)\}$ taken over all possible indices I and denote their greatest common divisor by $Q_j(t_1, \dots, t_s)$. (Note that because R is a unique factorization domain, \mathcal{L}_R is too, hence \mathcal{L}_R is a gcd domain.) Thus Q_j is well-defined up to a factor of $\varepsilon t_1^{e_1} \cdots t_s^{e_s}$, where ε is a unit of R and $e_1, \dots, e_s \in \mathbb{Z}$. Lemma 7.2 implies that the quotient

$$(18) \quad \Delta_{\Gamma, \alpha}^{\varrho}(t_1, \dots, t_s) = \frac{Q_j(t_1, \dots, t_s)}{\det(\Omega(1 - a_j))},$$

is independent, up to possibly a sign, of the column j chosen to remove from M , and Equation (18) defines the twisted Alexander polynomial associated to the group Γ , presentation P , surjection $\alpha: \Gamma \rightarrow \mathbb{Z}^s$ and representation $\varrho: \Gamma \rightarrow GL_n(R)$.

Notice that $\Delta_{\Gamma, \alpha}^{\varrho}(t_1, \dots, t_s)$ is not generally a polynomial, but rather a quotient of two Laurent polynomials. For virtual knots, we will show that the twisted Alexander polynomial is a Laurent polynomial over R , see Theorem 7.5 below (see [47, Proposition 8] for a similar but weaker result for classical knots, as well as [28, Theorem 3.1] by Kitano and Morifuji).

The definition (18) of the twisted Alexander polynomials requires a choice of presentation P for the group Γ . The Tietze transformation theorem implies that any two presentations P and P' of Γ are related by a sequence of Tietze moves and their inverses:

T1: Add a consequence r of the relators r_i .

T2: Add a new generator a and a new relator aw^{-1} , where w is a word in the a_j .

Wada studies the effect of the Tietze transformations on the twisted Alexander polynomials, and in [47, Theorem 1] he proves that $\Delta_{\Gamma, \alpha}^{\ell}(t_1, \dots, t_s)$ is independent of the choice of presentation P for Γ , up to a factor of $\varepsilon t_1^{e_1} \cdots t_s^{e_s}$.

Given a virtual knot or link K , we define the twisted virtual Alexander polynomial by applying this construction to the virtual knot group VG_K . We will show that the twisted Alexander polynomials associated to representations of the virtual knot group VG_K enjoy some special properties by showing that the presentations of VG_K one gets from diagrams of K are strongly Tietze equivalent.

Recall that two presentations P and P' of a group are said to be *strongly Tietze equivalent* if they are related by the following moves and their inverses:

- S1:** Replace one relator r_i by its inverse $(r_i)^{-1}$.
- S2:** Replace one relator r_i by a conjugate wr_iw^{-1} .
- S3:** Replace one relator r_i by the product $r_i r_j$.
- S4:** Add a new generator a and the relator aw^{-1} .

Note that **S4** is the same as **T2**.

Given a virtual knot diagram D of K , one can construct a presentation P_D of the virtual knot group VG_K as follows. It has one meridional generator for each short arc and two relations for each classical and virtual crossing as in Figure 5. In addition, it has two auxiliary generators s and q , along with the commutation relation $[s, q] = 1$. We call P_D the *Wirtinger-like* presentation associated with the diagram D for K , and the next result shows that any two such presentations are strongly Tietze equivalent. The argument is similar to the proof of Lemma 6 in [47].

Lemma 7.3. *If D and D' are two diagrams for the virtual knot K , then the presentations P_D and $P_{D'}$ of its virtual knot group VG_K are strongly Tietze equivalent.*

Proof. Let D and D' be two diagrams of K that are identical outside of the small neighborhood indicated in the left of Figure 22. Let P and P' be the corresponding presentations

$$P = \langle a_1, \dots, a_k, x, s, q \mid r_1, \dots, r_k, xs^{-1}a_k^{-1}s, [s, q] \rangle$$

and

$$P' = \langle a_1, \dots, a_k, s, q \mid r'_1, \dots, r'_k, [s, q] \rangle.$$

The relator r'_i is obtained from r_i by replacing occurrences of x by $s^{-1}a_k s$.

We can transform r_i to r'_i using strong Tietze moves as follows. Suppose that r_i contains an occurrence of x . We invert r_i so that it now contains an occurrence of x^{-1} . Let $r_i = ux^{-1}v$ where u and v are words in the generators of P . We make the following sequence of transformations using moves **S2** and **S3**

$$r_i \rightsquigarrow vr_i v^{-1} \rightsquigarrow vr_i v^{-1} xs^{-1} a_k^{-1} s \rightsquigarrow v^{-1} vr_i v^{-1} xs^{-1} a_k^{-1} sv = us^{-1} a_k^{-1} sv.$$

If D and D' are as indicated in the right of Figure 22, then we need to replace occurrences of x by $q^{-1}a_kq$. This can be done using a sequence of moves similar to the above sequence.

This shows that the first two generalized Reidemeister moves $(r1)$ and $(v1)$ can be realized by a sequence of strong Tietze moves. The other generalized Reidemeister moves $(r2)$, $(v2)$, $(r3)$, $(v3)$, and $(v4)$ of Figure 1 can be similarly realized by the strong Tietze move **S4**, and this completes the argument. \square

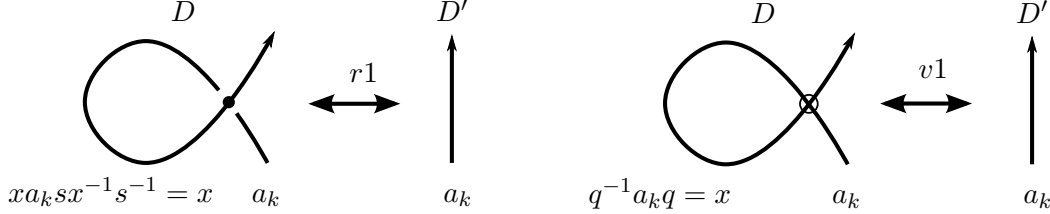

FIGURE 22. The first Reidemeister move.

Associated to any Wirtinger-like presentation

$$P = \langle a_1, \dots, a_k, s, q \mid r_1, \dots, r_k, [s, q] \rangle$$

is a surjection $\alpha: VG_K \rightarrow \mathbb{Z}^3$, where \mathbb{Z}^3 is generated by $\{s, t, q\}$. The homomorphism α sends each meridional generator a_j to t and the other generators s, q identically to themselves.

Definition 7.4. Let K be a virtual knot or link and $\varrho: VG_K \rightarrow GL_n(R)$ a representation of the virtual knot group. Then the *twisted virtual Alexander polynomial* is defined to be $H_K^\varrho(s, t, q) = \Delta_{VG_K, \alpha}^\varrho(s, t, q)$.

Note that if K is classical, then $H_K^\varrho(s, t, q) = 0$. Thus the twisted virtual Alexander polynomial is an obstruction to K being classical.

Given a representation $\varrho: VG_K \rightarrow GL_n(R)$, we define the twisted Alexander matrix $A = \Omega\left(\frac{\partial r_i}{\partial a_j}\right)$ to be the $k \times k$ block of the twisted presentation matrix M associated to the above presentation P .

Theorem 7.5. For a virtual knot or link K and representation $\varrho: VG_K \rightarrow GL_n(R)$, the twisted virtual Alexander polynomial satisfies $H_K^\varrho(s, t, q) = \det(A)$. Thus $H_K^\varrho(s, t, q)$ is a Laurent polynomial with coefficients in R .

Proof. Using the above presentation P of the virtual knot group VG_K , we obtain the twisted presentation matrix

$$M = \begin{bmatrix} A & \Omega\left(\frac{\partial r}{\partial s}\right) & \Omega\left(\frac{\partial r}{\partial q}\right) \\ \mathbf{0} & \Omega(1 - q) & \Omega(s - 1) \end{bmatrix}.$$

Clearly $\det(\Omega(1 - q))$ is non-zero, and since \widehat{M}_{n+2} is square, equation (18) implies that

$$(19) \quad \Delta_{VG_K, \alpha}^\varrho(s, t, q) = \frac{\det(\widehat{M}_{n+2})}{\det(\Omega(1 - q))}.$$

Since \widehat{M}_{n+2} is block upper triangular, we have $\det(\widehat{M}_{n+2}) = \det(A) \det(\Omega(1 - q))$. Now equation (19) implies that $\Delta_{VG_K, \alpha}^{\varrho}(s, t, q) = \det(A)$, and the statement of the theorem follows. \square

We say that two representations $\varrho_1, \varrho_2: VG_K \rightarrow GL_n(R)$ are conjugate if there exists $P \in GL_n(R)$ such that $\varrho_1(g) = P\varrho_2(g)P^{-1}$ for all $g \in VG_K$. It is straightforward to verify the following elementary result.

Lemma 7.6. *If $\varrho_1: VG_K \rightarrow GL_n(R)$ and $\varrho_2: VG_K \rightarrow GL_n(R)$ are conjugate representations, then $H_K^{\varrho_1}(s, t, q) = H_K^{\varrho_2}(s, t, q)$.*

In [47, Theorem 2], Wada shows that the twisted Alexander polynomials of classical knots have less indeterminacy than the invariants for arbitrary groups. The next theorem proves the same result for virtual knots, and we include a proof for the convenience of the reader.

Theorem 7.7. *Let $\varrho: VG_K \rightarrow GL_n(R)$ be a representation. As an invariant of the oriented virtual link type of K , the twisted virtual Alexander polynomial $H_K^{\varrho}(s, t, q)$ is well-defined up to a factor of $\varepsilon(s^{e_1}t^{e_2}q^{e_3})^n$, where ε is a unit of R and $e_1, e_2, e_3 \in \mathbb{Z}$.*

If $\varrho: VG_K \rightarrow SL_n(R)$ is unimodular, then the twisted virtual Alexander polynomial $H_K^{\varrho}(s, t, q)$ is well-defined up to a factor of $\pm(s^{e_1}t^{e_2}q^{e_3})^n$ if n is odd and $(s^{e_1}t^{e_2}q^{e_3})^n$ if n is even.

Proof. The oriented virtual knot type of K consists of the set of oriented virtual knot diagrams of K modulo the generalized Reidemeister moves, see Figure 1. Each knot diagram of K is related by a sequence of strong Tietze moves as was shown in Lemma 7.3.

Let K have the following Wirtinger-like presentation of its virtual knot group $VG_K = \langle a_1, \dots, a_k, s, q \mid r_1, \dots, r_k, [s, q] \rangle$ and let

$$M = \begin{bmatrix} A & \Omega\left(\frac{\partial r}{\partial s}\right) & \Omega\left(\frac{\partial r}{\partial q}\right) \\ \mathbf{0} & \Omega(1 - q) & \Omega(s - 1) \end{bmatrix}$$

be the associated twisted presentation matrix.

Under the strong Tietze move **S1**, we replace a relator r_i by its inverse r_i^{-1} . The corresponding twisted presentation matrix M' is then obtained from M by replacing the matrix row $\Omega\left(\frac{\partial r_i}{\partial a_j}\right)$ with $\Omega\left(-\frac{\partial r_i}{\partial a_j}\right)$. If A' is the twisted Alexander matrix of M' , then $\det(A') = (\pm 1)^n \det(A)$.

Under the move **S2**, we replace a relator r_i by a conjugate wr_iw^{-1} . Since $\frac{\partial w^{-1}}{\partial a_j} = -w^{-1}\frac{\partial w}{\partial a_j}$, we see that

$$\begin{aligned} \frac{\partial(wr_iw^{-1})}{\partial a_j} &= \frac{\partial w}{\partial a_j} + w\frac{\partial r_i}{\partial a_j} + wr_i\frac{\partial w^{-1}}{\partial a_j} \\ &= (1 - wr_iw^{-1})\frac{\partial w}{\partial a_j} + w\frac{\partial r_i}{\partial a_j}. \end{aligned}$$

Applying $\tilde{\rho} \otimes \tilde{\alpha}$ and using the fact that $\rho(wr_i w^{-1}) = I_n$, it follows that the twisted Alexander matrix M' is obtained from M by replacing the matrix row $\Omega\left(\frac{\partial r_i}{\partial a_j}\right)$ by $\Omega(w)\Omega\left(\frac{\partial r_i}{\partial a_j}\right)$. We compute that

$$\det(\Omega(w)) = \det(\rho(w)) \det(\alpha(w))^n = \varepsilon(s^{e_1} t^{e_2} q^{e_3})^n.$$

If ρ is unimodular, then $\det(\rho(w)) = 1$.

Under the move **S3**, we replace a relator r_i by the product $r_i r_k$. The twisted presentation matrix M' is then obtained from M by replacing the matrix row $\Omega\left(\frac{\partial r_i}{\partial a_j}\right)$ by $\Omega\left(\frac{\partial r_i}{\partial a_j}\right) + \Omega(r_i)\Omega\left(\frac{\partial r_k}{\partial a_j}\right)$. Since each row of A' is a linear combination of the rows of A , we have that $\det(A') = \det(A)$.

Notice that the last strong Tietze move **S4** coincides with the Tietze move **T2**. In proof of [47, Theorem 1], Wada shows that the twisted Alexander polynomial of a finitely presentable group Γ is independent of second Tietze move **T2**. More precisely, if P' is obtained from P by the move **T2**, and if M and M' are the respective twisted presentation matrices, then Wada shows that $\det(M'_j) = \det(M_j^J)$. \square

As in the untwisted case, we suppress the indeterminacy of the twisted virtual Alexander polynomial and simply write $H_K^{\rho}(s, t, q) = f$ for any $f \in \mathcal{L}_R$ if they are equal up to the indeterminacy indicated in Theorem 7.7.

The following result shows that twisted virtual Alexander polynomial also carries virtual crossing number information, compare with Theorem 3.4.

Theorem 7.8. *If K is a virtual knot or link, $\rho: VG_K \rightarrow GL_n(R)$ is a representation and $H_K^{\rho}(s, t, q)$ is its twisted virtual Alexander polynomial, then*

$$q\text{-width } H_K^{\rho}(s, t, q) \leq 2n v(K).$$

Proof. Suppose that K admits a diagram with m virtual crossings. Then the corresponding twisted virtual Alexander matrix A has $2n \cdot m$ rows with a q or q^{-1} . It follows that after a suitable normalization, the q -width of $\det(A)$ is at most $2nm$. \square

In Section 3 we used the virtual Alexander polynomial to give lower bounds on the virtual crossing number $v(K)$ for several virtual knots. We will now show how to improve those bounds using twisted Alexander polynomials associated with representations $\rho: VG_K \rightarrow SL_2(\mathbb{F}_2)$, where \mathbb{F}_2 denotes the field with two elements. The computations in the following examples were performed using `sage` [46].

Example 7.9. Consider the virtual knot $K = 3.4$. A simple computation shows that $H_K(s, t, q) = (s - q)(1 - st)(1 - qt)$. Since $H_K(s, t, q)$ has q -width equal to 2, Theorem 3.4 implies that $v(K) \geq 1$. This bound is not sharp.

Using the twisted virtual Alexander polynomials, we can obtain a sharp bound for $v(K)$. From the diagram of K in Figure 23, we find the following presentation for VG_K , which

can be simplified to a presentation with only one meridional generator as follows:

$$\begin{aligned} VG_K &= \langle a, b, c, s, q \mid [s, q], a^{-1}qs^{-2}a^{-1}s^2q^{-2}cq^2s^{-1}asq^{-1}, b^{-1}s^{-1}a^{-1}q^2s^{-2}as^3q^{-2}a, \\ &\quad c^{-1}q^2s^{-3}a^{-1}s^3q^{-3}bq^3s^{-2}as^2q^{-2} \rangle, \\ &= \langle a, s, q \mid [s, q], a^{-1}qs^{-2}a^{-1}s^{-1}a^{-1}s^2q^{-3}a^{-1}q^2s^{-2}as^3q^{-2}aq^3s^{-2}asasq^{-1} \rangle. \end{aligned}$$

Setting $r = a^{-1}qs^{-2}a^{-1}s^{-1}a^{-1}s^2q^{-3}a^{-1}q^2s^{-2}as^3q^{-2}aq^3s^{-2}asasq^{-1}$, we compute the Fox derivative

$$\begin{aligned} \frac{\partial r}{\partial a} &= -a^{-1} - a^{-1}qs^{-2}a^{-1} - a^{-1}qs^{-1}(s^{-1}a^{-1})^2 - a^{-1}qs^{-1}(s^{-1}a^{-1})^2s^2q^{-3}a^{-1} \\ &\quad + a^{-1}qs^{-1}(s^{-1}a^{-1})^2s^2q^{-3}a^{-1}q^2s^{-2} + a^{-1}qs^{-1}(s^{-1}a^{-1})^2s^2q^{-3}a^{-1}q^2s^{-2}as^3q^{-2} \\ &\quad + a^{-1}qs^{-1}(s^{-1}a^{-1})^2s^2q^{-3}a^{-1}q^2s^{-2}as^3q^{-2}aq^3s^{-2} \\ &\quad + a^{-1}qs^{-1}(s^{-1}a^{-1})^2s^2q^{-3}a^{-1}q^2s^{-2}as^3q^{-2}aq^3s^{-2}as. \end{aligned}$$

Let $\varrho: VG_K \rightarrow SL_2(\mathbb{F}_2)$ be the representation defined by setting

$$a = \begin{bmatrix} 0 & 1 \\ 1 & 0 \end{bmatrix}, \quad s = \begin{bmatrix} 0 & 1 \\ 1 & 1 \end{bmatrix}, \quad q = \begin{bmatrix} 0 & 1 \\ 1 & 1 \end{bmatrix},$$

we compute the determinant of $\Omega\left(\frac{\partial r}{\partial a}\right)$ and deduce that the twisted virtual Alexander polynomial is given by

$$H_K^{\varrho}(s, t, q) = (s - q)^2(tq - 1)^2(st - 1)^2(stq - s - q)^2.$$

Since $H_K^{\varrho}(s, t, q)$ has q -width = 6, it follows that $v(K) \geq 2$. Comparing to Figure 23, we see this bound is sharp.

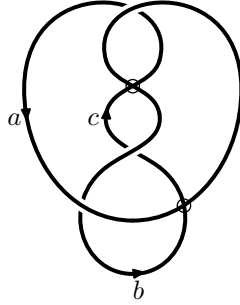

FIGURE 23. The virtual knot 3.4 has $v(K) = 2$.

Example 7.10. Let K be the virtual knot 4.71. A straightforward computation shows that $H_K(s, t, q) = 0$. From the diagram of K in Figure 24, we derive the following presentation for VG_K :

$$\begin{aligned} VG_K &= \langle a, b, s, q \mid [s, q], a^{-1}bs^{-1}q^2aq^{-2}s^2b^{-1}as^{-2}q^2b^{-1}q^{-2}s, \\ &\quad ba^{-1}q^{-2}s^2bs^{-1}q^2ab^{-1}q^{-2}sa^{-1}s^{-2}q^2 \rangle. \end{aligned}$$

Setting

$$\begin{aligned} r_1 &= a^{-1}bs^{-1}q^2aq^{-2}s^2b^{-1}as^{-2}q^2b^{-1}q^{-2}s, \\ r_2 &= ba^{-1}q^{-2}s^2bs^{-1}q^2ab^{-1}q^{-2}sa^{-1}s^{-2}q^2, \end{aligned}$$

we compute the Fox derivatives

$$\begin{aligned} \frac{\partial r_1}{\partial a} &= -a^{-1} + a^{-1}bs^{-1}q^2 + a^{-1}bs^{-1}q^2aq^{-2}s^2b^{-1}, \\ \frac{\partial r_1}{\partial b} &= a^{-1} - a^{-1}bs^{-1}q^2aq^{-2}s^2b^{-1} - a^{-1}bs^{-1}q^2aq^{-2}s^2b^{-1}as^{-2}q^2b^{-1}, \\ \frac{\partial r_2}{\partial a} &= -ba^{-1} + ba^{-1}q^{-2}s^2bs^{-1}q^2 - ba^{-1}q^{-2}s^2bs^{-1}q^2ab^{-1}q^{-2}sa^{-1}, \\ \frac{\partial r_2}{\partial b} &= 1 + ba^{-1}q^{-2}s^2 - ba^{-1}q^{-2}s^2bs^{-1}q^2ab^{-1}. \end{aligned}$$

Let $\varrho: VG_K \rightarrow SL_2(\mathbb{F}_2)$ be the representation defined by setting

$$a = \begin{bmatrix} 0 & 1 \\ 1 & 0 \end{bmatrix}, \quad b = \begin{bmatrix} 1 & 0 \\ 1 & 1 \end{bmatrix}, \quad s = \begin{bmatrix} 0 & 1 \\ 1 & 1 \end{bmatrix}, \quad q = \begin{bmatrix} 1 & 0 \\ 0 & 1 \end{bmatrix}.$$

Applying Ω to the twisted Alexander matrix, we compute that the twisted virtual Alexander polynomial is given by

$$H_K^{\varrho}(s, t, q) = (1 - st)^2(s^2 + sq + q^2)^2(tq^2 - s)^2.$$

Since $H_K^{\varrho}(s, t, q)$ has q -width = 8, it follows that $v(K) \geq 2$. Since K has a diagram with three virtual crossings, we conclude that $v(K) = 2$ or 3.

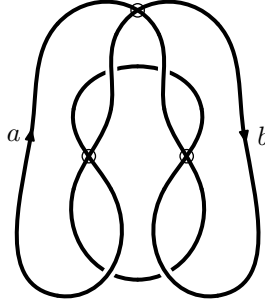

FIGURE 24. The virtual knot 4.71.

Example 7.11. Let K be the virtual knot 4.98. An easy computation shows that $H_K(s, t, q) = 0$. From the diagram of K in Figure 25, we derive the following presentation for VG_K :

$$\begin{aligned} VG_K &= \langle a, b, s, q \mid [s, q], q^{-2}a^{-1}sbaq^4s^{-3}as^4q^{-4}a^{-1}b^{-1}s^{-1}aq^2s^{-1}b^{-1}, \\ &\quad a^{-1}sbaq^2s^{-2}a^{-1}s^3q^{-4}a^{-1}sbaq^4s^{-3}as^2q^{-2}a^{-1}b^{-1}s^{-2} \rangle. \end{aligned}$$

Setting

$$\begin{aligned} r_1 &= q^{-2}a^{-1}sbaq^4s^{-3}as^4q^{-4}a^{-1}b^{-1}s^{-1}aq^2s^{-1}b^{-1}, \\ r_2 &= a^{-1}sbaq^2s^{-2}a^{-1}s^3q^{-4}a^{-1}sbaq^4s^{-3}as^2q^{-2}a^{-1}b^{-1}s^{-2}, \end{aligned}$$

we compute the Fox derivatives

$$\begin{aligned} \frac{\partial r_1}{\partial a} &= -q^{-2}a^{-1} + q^{-2}a^{-1}sb + q^{-2}a^{-1}sbaq^4s^{-3} - q^{-2}a^{-1}sbaq^4s^{-3}as^4q^{-4}a^{-1} \\ &\quad + q^{-2}a^{-1}sbaq^4s^{-3}as^4q^{-4}a^{-1}b^{-1}s^{-1}, \end{aligned}$$

$$\begin{aligned} \frac{\partial r_1}{\partial b} &= q^{-2}a^{-1}s - q^{-2}a^{-1}sbaq^4s^{-3}as^4q^{-4}a^{-1}b^{-1} \\ &\quad - q^{-2}a^{-1}sbaq^4s^{-3}as^4q^{-4}a^{-1}b^{-1}s^{-1}aq^2s^{-1}b^{-1}, \end{aligned}$$

$$\begin{aligned} \frac{\partial r_2}{\partial a} &= -a^{-1} + a^{-1}sb - a^{-1}sbaq^2s^{-2}a^{-1} - a^{-1}sbaq^2s^{-2}a^{-1}s^3q^{-4}a^{-1} \\ &\quad + a^{-1}sbaq^2s^{-2}a^{-1}s^3q^{-4}a^{-1}sb + a^{-1}sbaq^2s^{-2}a^{-1}s^3q^{-4}a^{-1}sbaq^4s^{-3} \\ &\quad - a^{-1}sbaq^2s^{-2}a^{-1}s^3q^{-4}a^{-1}sbaq^4s^{-3}as^2q^{-2}a^{-1}, \end{aligned}$$

$$\frac{\partial r_2}{\partial b} = a^{-1}s + a^{-1}sbaq^2s^{-2}a^{-1}s^3q^{-4}a^{-1}s - a^{-1}sbaq^2s^{-2}a^{-1}s^3q^{-4}a^{-1}sbaq^4s^{-3}as^2q^{-2}a^{-1}b^{-1}.$$

Let $\varrho: VG_K \rightarrow SL_2(\mathbb{F}_2)$ be the representation defined by setting

$$a = \begin{bmatrix} 0 & 1 \\ 1 & 0 \end{bmatrix}, \quad b = \begin{bmatrix} 1 & 0 \\ 1 & 1 \end{bmatrix}, \quad s = \begin{bmatrix} 1 & 0 \\ 0 & 1 \end{bmatrix}, \quad q = \begin{bmatrix} 1 & 0 \\ 0 & 1 \end{bmatrix}.$$

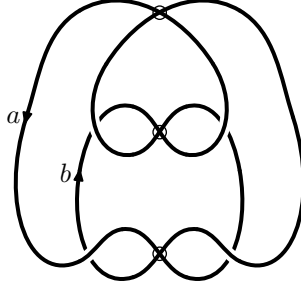

FIGURE 25. The virtual knot 4.98.

Applying Ω to the twisted Alexander matrix, we compute that the twisted virtual Alexander polynomial is given by

$$H_K^{\varrho}(s, t, q) = (s - q)^4(1 - st)^2(s - tq^2)^2.$$

Since $H_K^{\varrho}(s, t, q)$ has q -width = 8, it follows that $v(K) \geq 2$. Since K has a diagram with three virtual crossings, we conclude that $v(K) = 2$ or 3.

8. TWISTED VIRTUAL ALEXANDER POLYNOMIALS VIA BRAIDS

In this section, we relate the twisted Alexander polynomial of a virtual knot or link to the twisted virtual Burau representation, and we use this to establish twisted analogues of the results from Section 4. Throughout this section, we assume R is a unique factorization domain and $\mathcal{L}_R = R[s^{\pm 1}, t^{\pm 1}, q^{\pm 1}]$ will denote the ring of Laurent polynomials over R .

Let K be a virtual knot or link obtained as the closure of a virtual braid $\beta \in VB_k$. Recall that the virtual knot group of K has a presentation

$$VG_\beta = \langle x_1, \dots, x_k, s, q \mid x_1 = x_1^\beta, \dots, x_k = x_k^\beta, [s, q] = 1 \rangle,$$

see (8). Here, the notation VG_β indicates that the virtual knot group VG_K is equipped with the above presentation. A representation $\varrho: VG_\beta \rightarrow GL_n(R)$ extends to a representation $\varrho: F_{k+2} = \langle x_1, \dots, x_k, s, q \rangle \rightarrow GL_n(R)$, where we reuse the symbol ϱ to avoid an excess of notation, given by composition with the homomorphism $\pi_\beta: F_{k+2} \rightarrow VG_\beta$ that takes a generator to a generator of the same name.

The first result is the twisted analogue of Theorem 4.4, interpreting the twisted virtual Alexander polynomial in terms of the twisted Burau representation.

Theorem 8.1. *Let $\beta \in VB_k$ be a virtual braid and let K be the virtual knot or link obtained from the closure of β . Let $\varrho: VG_\beta \rightarrow GL_n(R)$ be a representation. Then the virtual twisted Alexander polynomial of K as in Definition 7.4 is given by*

$$H_K^\varrho(s, t, q) = \det(\Psi_\varrho(\beta) - I_{nk})$$

where Ψ_ϱ is the ϱ -twisted Burau representation as in Definition 4.3.

Proof. It is not difficult to verify that the given presentation of VG_β is strongly Tietze equivalent to the Wirtinger-like presentation obtained from the diagram of $K = \widehat{\beta}$ as the braid closure. In fact, this can be achieved using exclusively **S4** moves. The conclusion then follows from Theorem 7.5. \square

Define the polynomial invariant $H_\beta^\varrho(s, t, q) \in \mathcal{L}_R$ of a virtual braid $\beta \in VB_k$ and an arbitrary representation $\varrho: F_{k+2} \rightarrow GL_n(R)$ by

$$(20) \quad H_\beta^\varrho(s, t, q) = \det(\Psi_\varrho(\beta) - I_{nk}).$$

We will use this approach to extend certain results to the twisted setting. The following observation, which can be verified by direct calculation, shows that the images of the generators $\sigma_i, \sigma_i^{-1}, \tau_i \in VB_k$ under Ψ_ϱ are given by the following $nk \times nk$ matrices:

(21)

$$\begin{aligned}
\Psi_\varrho(\sigma_i) &= \begin{bmatrix} I_{n(i-1)} & \cdots & \mathbf{0} \\ & 0 & \varrho(s)s & \vdots \\ \vdots & \varrho(x_{i+1})t & I_n - \varrho(x_{i+1}x_i s x_{i+1}^{-1})st & \\ \mathbf{0} & \cdots & & I_{n(k-i-1)} \end{bmatrix}, \\
\Psi_\varrho(\sigma_i^{-1}) &= \begin{bmatrix} I_{n(i-1)} & \cdots & \mathbf{0} \\ & \varrho(s^{-1}x_i^{-1} s x_{i+1}) - \varrho(s^{-1}x_i^{-1})s^{-1}t^{-1} & \varrho(s^{-1}x_i^{-1}s)t^{-1} & \vdots \\ \vdots & & 0 & \\ \mathbf{0} & \cdots & & I_{n(k-i-1)} \end{bmatrix}, \\
\Psi_\varrho(\tau_i) &= \begin{bmatrix} I_{n(i-1)} & \cdots & \mathbf{0} \\ & 0 & \varrho(q)q & \vdots \\ \vdots & \varrho(q^{-1})q^{-1} & 0 & \\ \mathbf{0} & \cdots & & I_{n(k-i-1)} \end{bmatrix}.
\end{aligned}$$

Recall from Section 4 that for $\varrho: F_{k+2} \rightarrow GL_n(R)$ and $\beta \in VB_k$, we write $\beta_*\varrho$ for $\Phi(\beta)_*\varrho$, where $\Phi: F_{k+2} \rightarrow \text{Aut}(F_{k+2} \text{ rel } \{s, q\})$ is the fundamental representation. We will see how to determine $\Psi_{\beta_*\varrho}(g_i)$ for a generator g_i of VB_k .

Remark 8.2. Suppose $g_i \in \{\sigma_i, \sigma_i^{-1}, \tau_i\}$ is a generator of VB_k . By equation (12), it follows that $\Psi_\varrho(g_i\beta) = \Psi_{\beta_*\varrho}(g_i)\Psi_\varrho(\beta)$. Then $\Psi_{\beta_*\varrho}(g_i)$ is obtained by making a small modification to the matrices in (21).

For instance, if $g_i = \sigma_i$, then since $\beta_*\varrho(x_i) = \varrho(x_i^\beta)$, (21) implies that

$$\Psi_{\beta_*\varrho}(\sigma_i) = \begin{bmatrix} I_{n(i-1)} & \cdots & \mathbf{0} \\ & 0 & \varrho(s)s & \vdots \\ \vdots & \varrho(x_{i+1}^\beta)t & I_n - \varrho(x_{i+1}^\beta x_i^\beta s (x_{i+1}^\beta)^{-1})st & \\ \mathbf{0} & \cdots & & I_{n(k-i-1)} \end{bmatrix}.$$

A similar argument leads to corresponding formulas for $\Psi_{\beta_*\varrho}(\sigma_i^{-1})$ and $\Psi_{\beta_*\varrho}(\tau_i)$, though in the latter case, note that since $\beta_*(q) = q$, we have $\Psi_{\beta_*\varrho}(\tau_i) = \Psi_\varrho(\tau_i)$. When applied inductively, these formulas determine $\Psi_\varrho(\beta)$ for any braid β once it is written as a word in the generators.

Next, we prove a twisted analogue of Theorem 4.5.

Theorem 8.3. *Let K be a virtual knot or link and $\varrho: VG_K \rightarrow GL_n(R)$ a representation. Then the twisted virtual Alexander polynomial satisfies $H_K^\varrho(s, t, q) = H_K^\varrho(sq^{-1}, tq, 1)$.*

Proof. Let $\beta \in VB_k$ be a virtual braid with $K = \widehat{\beta}$, and let $\varrho: F_{k+2} \rightarrow GL_n(R)$ a representation satisfying $\beta_*\varrho = \varrho$. If $\beta = \theta_1 \cdots \theta_\ell$, where $\theta_j \in \{\sigma_i^{\pm 1}, \tau_i \mid 1 \leq i \leq k-1\}$, then we set $|\beta| = \ell$, which is the length of β as a word in the standard generators. Consider the diagonal $kn \times kn$ block matrix

$$\Lambda = \begin{bmatrix} I_n & \cdots & 0 \\ & qI_n & \vdots \\ \vdots & & \ddots \\ 0 & \cdots & q^{k-1}I_n \end{bmatrix}.$$

We will argue by induction on $|\beta|$ that

$$(22) \quad \Lambda \Psi_\varrho(\beta) \Lambda^{-1}(s, t, q) = \Psi_\varrho(\beta)(sq^{-1}, tq, 1).$$

If $|\beta| = 1$, then $\beta = \theta_1$ where $\theta_1 \in \{\sigma_i^{\pm 1}, \tau_i \mid 1 \leq i \leq k-1\}$. Using equation (21), it is easy to check that

$$\Lambda \Psi_\varrho(\theta_1) \Lambda^{-1}(s, t, q) = \Psi_\varrho(\theta_1)(sq^{-1}, tq, 1).$$

This proves the base case of our induction. Using Remark 8.2, one can similarly check that

$$\Lambda \Psi_{\beta_*\varrho}(\theta_1) \Lambda^{-1}(s, t, q) = \Psi_{\beta_*\varrho}(\theta_1)(sq^{-1}, tq, 1).$$

This observation will be used in the inductive step of the argument below.

Now suppose, by induction, that equation (22) holds for all braids β of length ℓ . Given a braid β' of length $\ell + 1$, then we can write it as $\beta' = \theta_1\beta$, where $|\beta| = \ell$. By the inductive hypothesis and the above observation, it follows that

$$\begin{aligned} \Lambda \Psi_\varrho(\beta') \Lambda^{-1}(s, t, q) &= \Lambda \Psi_{\beta_*\varrho}(\theta_1) \Lambda^{-1}(s, t, q) \Lambda \Psi_\varrho(\beta) \Lambda^{-1}(s, t, q) \\ &= \Psi_{\beta_*\varrho}(\theta_1)(sq^{-1}, tq, 1) \Psi_\varrho(\beta)(sq^{-1}, tq, 1) \\ &= \Psi_\varrho(\beta)(sq^{-1}, tq, 1). \end{aligned}$$

This completes the proof of (22), and this shows that

$$\begin{aligned} H_\beta^\varrho(s, t, q) &= \det(\Psi_\varrho(\beta) - I_{kn}) \\ &= \det(\Lambda \Psi_\varrho(\beta) \Lambda^{-1} - I_{kn}) \\ &= H_\beta^\varrho(sq^{-1}, tq, 1). \end{aligned}$$

It follows that $H_K^\varrho(s, t, q) = H_K^\varrho(sq^{-1}, tq, 1)$. \square

Just as in Remark 4.6, one can easily see that $H_K^\varrho(s, t, q) = H_K^\varrho(1, ts, qs^{-1}) = H_K^\varrho(st, 1, qt)$.

We now prove a twisted analogue of Lemma 4.9. The proof requires us to assume that $\varrho(s) = \varrho(q) = I$, but our computations suggest this result holds under the weaker assumption that $\varrho(s) = \varrho(q)$.

Lemma 8.4. *Let K be a virtual knot or link and $\varrho: VG_K \rightarrow GL_n(R)$ a representation of the virtual knot group such that $\varrho(s) = \varrho(q) = I_n$. Then $H_K^\varrho(s, t, 1)$ is divisible by $(s-1)^n$.*

Proof. Using a virtual knot diagram, we obtain a Wirtinger-like presentation of the virtual knot group $VG_K = \langle a_1, \dots, a_k, s, q \mid r_1, \dots, r_k, [s, q] \rangle$. Let

$$M = \begin{bmatrix} A & \Omega\left(\frac{\partial r}{\partial s}\right) & \Omega\left(\frac{\partial r}{\partial q}\right) \\ \mathbf{0} & \Omega(1-q) & \Omega(s-1) \end{bmatrix}$$

be the associated twisted presentation matrix and let A_1, \dots, A_k be the block columns of twisted Alexander matrix A . Applying Ω to the fundamental identity (3), after replacing n by k in (3), yields

$$(23) \quad \sum_{j=1}^k A_j \Omega(a_j - 1) + \Omega\left(\frac{\partial r}{\partial s}\right) \Omega(s-1) + \Omega\left(\frac{\partial r}{\partial q}\right) \Omega(q-1) = \mathbf{0}.$$

For $1 \leq j \leq k$, let $B_j = \Omega(a_j - 1) = \varrho(a_j)t - I_n$. Also let

$$A' = A \begin{bmatrix} B_1 & 0 & \cdots & 0 \\ B_2 & I_n & & \vdots \\ \vdots & \vdots & \ddots & 0 \\ B_k & 0 & \cdots & I_n \end{bmatrix}.$$

Observe that $\det(A') = \det(A) \det(B_1) = H_K^\varrho(s, t, q) \det(\varrho(a_1)t - I_n)$. We have,

$$\Omega(s-1) = \varrho(s)s - I_n = (s-1)I_n \quad \text{and} \quad \Omega(q-1) = \varrho(q)q - I_n = (q-1)I_n.$$

By (23) and the above expressions for $\Omega(s-1)$ and $\Omega(q-1)$, the first block column of A' is

$$\sum_{j=1}^k A_j B_j = -\Omega\left(\frac{\partial r}{\partial s}\right) (s-1) - \Omega\left(\frac{\partial r}{\partial q}\right) (q-1)$$

Evaluating at $q = 1$, we see that each of the first n columns of $A'|_{q=1}$ is of the form $(s-1)$ times a column vector. Hence $\det(A')|_{q=1} = (s-1)^n p(s, t)$ for some polynomial $p(s, t)$. It follows that

$$H_K^\varrho(s, t, 1) \det(\varrho(a_1)t - I_n) = (s-1)^n p(s, t)$$

and so $H_K^\varrho(s, t, 1)$ is divisible by $(s-1)^n$. \square

Combining Theorem 8.3 and Lemma 8.4 yields:

Corollary 8.5. *If K is a virtual knot or link and $\varrho: VG_K \rightarrow GL_n(R)$ is a representation such that $\varrho(s) = \varrho(q) = I_n$, then $H_K^\varrho(s, t, q)$ is divisible by $(s-q)^n$.*

9. A NORMALIZATION FOR THE TWISTED VIRTUAL ALEXANDER POLYNOMIAL

In this section, we give a normalization for the twisted Alexander polynomial of a virtual knot or link. Throughout this section, we assume R is a unique factorization domain and $\mathcal{L}_R = R[s^{\pm 1}, t^{\pm 1}, q^{\pm 1}]$ will denote the ring of Laurent polynomials over R .

In order to define the normalization, we consider the effect of the virtual Markov moves VM1, VM2, VM3 on $H_\beta^\varrho(s, t, q)$.

Proposition 9.1. *Let $\beta, \gamma \in VB_k$. Assume $\beta_*\varrho = \varrho$. Then*

$$H_{\gamma\beta\gamma^{-1}}^{\gamma_*\varrho}(s, t, q) = H_{\beta}^{\varrho}(s, t, q).$$

Proof. We have

$$\begin{aligned} H_{\gamma\beta\gamma^{-1}}^{\gamma_*\varrho}(s, t, q) &= \det(\Psi_{\gamma_*\varrho}(\gamma\beta\gamma^{-1}) - I_{nk}) \\ &= \det(\Psi_{\beta_*\varrho}(\gamma)\Psi_{\varrho}(\beta)\Psi_{\varrho}(\gamma)^{-1} - I_{nk}) && \text{by (14)} \\ &= \det(\Psi_{\varrho}(\gamma)\Psi_{\varrho}(\beta)\Psi_{\varrho}(\gamma)^{-1} - I_{nk}) && \text{since } \beta_*\varrho = \varrho \\ &= \det(\Psi_{\varrho}(\beta) - I_{nk}) = H_{\beta}^{\varrho}(s, t, q). \end{aligned}$$

□

Next, we examine how $H_{\beta}^{\varrho}(s, t, q)$ changes under a VM2 move. Recall from Section 5 that there is a natural inclusion $VB_k \hookrightarrow VB_{k+1}$ that we use to identify $\beta \in VB_k$ with its image under this map. Thus $\beta' = \beta\tau_k$ for a stabilization of virtual type, $\beta' = \beta\sigma_k^{-1}$ for a stabilization of positive type and $\beta' = \beta\sigma_k$ for a stabilization of negative type.

Proposition 9.2. *Let $\beta \in VB_k$ and assume $\beta' \in VB_{k+1}$ is obtained from β by a right stabilization. Let $\varrho: F_{k+2} \rightarrow GL_n(R)$ be a representation satisfying $\beta_*\varrho = \varrho$, and define $\varrho': F_{k+3} \rightarrow GL_n(R)$ by setting $\varrho'(s) = \varrho(s)$, $\varrho'(q) = \varrho(q)$, $\varrho'(x_i) = \varrho(x_i)$ for $1 \leq i \leq k$ and*

$$\varrho'(x_{k+1}) = \begin{cases} \varrho(q^{-1}x_kq) & \text{if } \beta' = \beta\tau_k, \\ \varrho(s^{-1}x_k s) & \text{if } \beta' = \beta\sigma_k^{\pm 1}. \end{cases}$$

Then ϱ' satisfies $\beta'_\varrho' = \varrho'$. Furthermore, if β' is obtained from β by a stabilization of virtual or of positive type then*

$$H_{\beta'}^{\varrho'}(s, t, q) = (-1)^n H_{\beta}^{\varrho}(s, t, q).$$

If β' is obtained from β by a stabilization of negative type then

$$H_{\beta'}^{\varrho'}(s, t, q) = (-st)^n \det \varrho(x_k s) H_{\beta}^{\varrho}(s, t, q).$$

Proof. Let $\Psi_{\varrho}: VB_k \rightarrow GL_{nk}(\mathcal{L}_R)$ and $\Psi'_{\varrho'}: VB_{k+1} \rightarrow GL_{n(k+1)}(\mathcal{L}_R)$ be the twisted Burau representations, and set $A = \Psi_{\varrho}(\beta)$ and $A' = \Psi'_{\varrho'}(\beta')$. We consider separately the case of a virtual, positive, and negative stabilization.

Virtual stabilization. Applying the fundamental representation (7) to $\beta' = \beta\tau_k$, we have

$$x_i^{\beta'} = \begin{cases} x_i^{\beta} & \text{if } 1 \leq i \leq k-1, \\ qx_{k+1}^{\beta}q^{-1} & \text{if } i = k, \\ q^{-1}x_k^{\beta}q & \text{if } i = k+1. \end{cases}$$

Assume $\beta_*\varrho = \varrho$. That $\varrho'(x_i^{\beta'}) = \varrho'(x_i)$ for $1 \leq i \leq k-1$ follows by definition, so we only need to check $i = k$ and $i = k+1$.

For $i = k$, we have

$$\varrho' \left(x_k^{\beta'} \right) = \varrho' \left(qx_{k+1}q^{-1} \right) = \varrho(x_k) = \varrho'(x_k).$$

For $i = k + 1$, we have

$$\varrho' \left(x_{k+1}^{\beta'} \right) = \varrho' \left(q^{-1}x_k^\beta q \right) = \varrho \left(q^{-1}x_k^\beta q \right) = \varrho \left(q^{-1}x_k q \right) = \varrho'(x_{k+1}).$$

Hence $\beta'_* \varrho' = \varrho'$. Also, by direct calculation, $(\tau_k)_* \varrho' = \varrho'$.

Writing A and A' as block matrices with entries in $M_n(\mathcal{L}_R)$, we see that they are related by:

$$\begin{aligned} A' &= \Psi'_{\varrho'}(\beta\tau_k) = \Psi'_{(\tau_k)_* \varrho'}(\beta) \Psi'_{\varrho'}(\tau_k) = \Psi'_{\varrho'}(\beta) \Psi'_{\varrho'}(\tau_k) \\ &= \begin{bmatrix} A & \mathbf{0} \\ \mathbf{0} & I_n \end{bmatrix} \begin{bmatrix} I_{n(k-1)} & \cdots & \mathbf{0} \\ \vdots & 0 & \varrho(q)q \\ \mathbf{0} & \varrho(q^{-1})q^{-1} & 0 \end{bmatrix}. \end{aligned}$$

Let A_k denote the k -th block column of A (so A_k has size $kn \times n$ when viewed as matrix over \mathcal{L}_R), and let E be the elementary block matrix

$$E = \begin{bmatrix} I_{n(k-1)} & \cdots & \mathbf{0} \\ \vdots & I_n & 0 \\ \mathbf{0} & \varrho(q^{-1})q^{-1} & I_n \end{bmatrix}.$$

Observe that

$$(A' - I_{n(k+1)}) E = \begin{bmatrix} A - I_{nk} & A_k \varrho(q)q \\ \mathbf{0} & -I_n \end{bmatrix}.$$

Viewing the above block matrix as a matrix in $M_{n(k+1)}(\mathcal{L}_R)$ and using the fact that $\det(E) = 1$, we find that

$$\begin{aligned} H_{\beta'}^{\varrho'}(s, t, q) &= \det(A' - I_{n(k+1)}) = \det((A' - I_{n(k+1)}) E) \\ &= \det \left(\begin{bmatrix} A - I_{nk} & A_k \varrho(q)q \\ \mathbf{0} & -I_n \end{bmatrix} \right) = (-1)^n \det(A - I_{nk}) \\ &= (-1)^n H_{\beta}^{\varrho}(s, t, q). \end{aligned}$$

Positive stabilization. Applying the fundamental representation (7) to $\beta' = \beta\sigma_k^{-1}$, we have

$$x_i^{\beta'} = \begin{cases} x_i^\beta & \text{if } 1 \leq i \leq k-1, \\ s^{-1} \left(x_k^\beta \right)^{-1} s x_{k+1}^\beta & \text{if } i = k, \\ s^{-1} x_k^\beta s & \text{if } i = k+1. \end{cases}$$

Assume $\beta_* \varrho = \varrho$. That $\varrho' \left(x_i^{\beta'} \right) = \varrho'(x_i)$ for $1 \leq i \leq k-1$ follows by definition, so we only need to check $i = k$ and $i = k+1$.

For $i = k$, we have

$$\begin{aligned}\varrho' \left(x_k^{\beta'} \right) &= \varrho' \left(s^{-1} \left(x_k^\beta \right)^{-1} s x_{k+1} x_k^\beta \right) \\ &= \varrho \left(s^{-1} \left(x_k^\beta \right)^{-1} s \right) \varrho' \left(x_{k+1} \right) \varrho \left(x_k^\beta \right) \\ &= \varrho \left(s^{-1} x_k^{-1} s \right) \varrho \left(s^{-1} x_k s \right) \varrho \left(x_k \right) = \varrho \left(x_k \right) = \varrho' \left(x_k \right).\end{aligned}$$

For $i = k + 1$, we have

$$\varrho' \left(x_{k+1}^{\beta'} \right) = \varrho' \left(s^{-1} x_k^\beta s \right) = \varrho \left(s^{-1} x_k^\beta s \right) = \varrho' \left(s^{-1} x_k s \right) = \varrho' \left(x_{k+1} \right).$$

Thus it follows that $\beta'_* \varrho' = \varrho'$. Also, by direct calculation, $(\sigma_k^{-1})_* \varrho' = \varrho'$.

Writing A and A' as block matrices with entries in $M_n(\mathcal{L}_R)$, using equation (21), the fact that $\varrho'(x_{k+1}) = \varrho(s^{-1}x_k s)$ and the assumption that $\varrho(x_k^\beta) = \varrho(x_k)$, we see that

$$\begin{aligned}A' &= \Psi'_{\varrho'}(\beta \sigma_k^{-1}) = \Psi'_{(\sigma_k^{-1})_* \varrho'}(\beta) \Psi'_{\varrho'}(\sigma_k^{-1}) = \Psi'_{\varrho'}(\beta) \Psi'_{\varrho'}(\sigma_k^{-1}) \\ &= \begin{bmatrix} A & \mathbf{0} \\ \mathbf{0} & I_n \end{bmatrix} \begin{bmatrix} I_{n(k-1)} & \cdots & \mathbf{0} \\ \vdots & I_n - \varrho(s^{-1}x_k^{-1})(st)^{-1} & \varrho(s^{-1}x_k^{-1}s)t^{-1} \\ \mathbf{0} & \varrho(s^{-1})s^{-1} & 0 \end{bmatrix}.\end{aligned}$$

Let A_k denote the k -th block column of A and let E be the elementary block matrix

$$E = \begin{bmatrix} I_{n(k-1)} & \cdots & \mathbf{0} \\ \vdots & I_n & 0 \\ \mathbf{0} & \varrho(s^{-1})s^{-1} & I_n \end{bmatrix}.$$

Observe that

$$(A' - I_{n(k+1)}) E = \begin{bmatrix} A - I_{nk} & A_k \varrho(s^{-1}x_k^{-1}s)t^{-1} \\ \mathbf{0} & -I_n \end{bmatrix}.$$

Viewing these $(k+1) \times (k+1)$ block matrices with entries in $M_n(\mathcal{L}_R)$ as matrices in $M_{n(k+1)}(\mathcal{L}_R)$, and using the fact that $\det(E) = 1$, it follows that

$$\begin{aligned}H_{\beta'}^{\varrho'}(s, t, q) &= \det(A' - I_{n(k+1)}) = \det((A' - I_{n(k+1)}) E) \\ &= \det \left(\begin{bmatrix} A - I_{nk} & A_k \varrho(x_k^{-1})t^{-1} \\ \mathbf{0} & -I_n \end{bmatrix} \right) = (-1)^n \det(A - I_{nk}) \\ &= (-1)^n H_{\beta}^{\varrho}(s, t, q).\end{aligned}$$

Negative stabilization. Applying the fundamental representation (7) to $\beta' = \beta\sigma_k$, we have

$$x_i^{\beta'} = \begin{cases} x_i^\beta & \text{if } 1 \leq i \leq k-1, \\ sx_{k+1}s^{-1} & \text{if } i = k, \\ x_{k+1}x_k^\beta sx_{k+1}^{-1}s^{-1} & \text{if } i = k+1. \end{cases}$$

Assume $\beta_*\varrho = \varrho$. That $\varrho'(x_i^{\beta'}) = \varrho'(x_i)$ for $1 \leq i \leq k-1$ follows by definition, so we only need to check $i = k$ and $i = k+1$.

For $i = k$, we have

$$\varrho'(x_k^{\beta'}) = \varrho'(sx_{k+1}s^{-1}) = \varrho(x_k) = \varrho'(x_k).$$

For $i = k+1$, we have

$$\begin{aligned} \varrho'(x_{k+1}^{\beta'}) &= \varrho'(x_{k+1}x_k^\beta sx_{k+1}^{-1}s^{-1}) \\ &= \varrho'(x_{k+1})\varrho(x_k^\beta)\varrho'(sx_{k+1}^{-1}s^{-1}) = \varrho'(x_{k+1})\varrho(x_k)\varrho(x_k^{-1}) = \varrho'(x_{k+1}). \end{aligned}$$

Thus it follows that $\beta'_*\varrho' = \varrho'$. Also, by direct calculation, $(\sigma_k)_*\varrho' = \varrho'$.

Writing A and A' as block matrices with entries in $M_n(\mathcal{L}_R)$, using equation (21) and the fact that $\varrho'(sx_{k+1}^{-1}) = \varrho(x_k^{-1}s)$, we see that

$$\begin{aligned} A' &= \Psi'_{\varrho'}(\beta\sigma_k) = \Psi'_{(\sigma_k)_*\varrho'}(\beta)\Psi'_{\varrho'}(\sigma_k) = \Psi'_{\varrho'}(\beta)\Psi'_{\varrho'}(\sigma_k) \\ &= \begin{bmatrix} A & \mathbf{0} \\ \mathbf{0} & I_n \end{bmatrix} \begin{bmatrix} I_{n(k-1)} & \cdots & \mathbf{0} \\ \vdots & 0 & \varrho(s)s \\ \mathbf{0} & \varrho'(x_{k+1})t & I_n - \varrho'(x_{k+1}s)st \end{bmatrix}. \end{aligned}$$

Let A_k denote the k -th block column of A and let E be the elementary block matrix

$$E = \begin{bmatrix} I_{n(k-1)} & \cdots & \mathbf{0} \\ \vdots & I_n & 0 \\ \mathbf{0} & \varrho(s^{-1})s^{-1} & I_n \end{bmatrix}.$$

Observe that

$$(A' - I_{n(k+1)})E = \begin{bmatrix} A - I_{nk} & A_k\varrho(s)s \\ \mathbf{0} & -\varrho'(x_{k+1}s)st \end{bmatrix}.$$

Viewing the above block matrix as a matrix in $M_{n(k+1)}(\mathcal{L}_R)$ and using the fact that $\det(E) = 1$ and $\det \varrho'(x_{k+1}s) = \det \varrho(s^{-1}x_k s^2) = \det \varrho(x_k s)$, it follows that

$$\begin{aligned} H_{\beta'}^{\varrho'}(s, t, q) &= \det(A' - I_{n(k+1)}) = \det((A' - I_{n(k+1)})E) \\ &= \det\left(\begin{bmatrix} A - I_{n(k+1)} & A_n \varrho(s) \\ \mathbf{0} & -\varrho'(x_{k+1}s)st \end{bmatrix}\right) \\ &= (-st)^n \det(\varrho'(x_{k+1}s)) \det(A - I_{nk}) \\ &= -(st)^n \det \varrho(x_k s) H_{\beta}^{\varrho}(s, t, q). \end{aligned}$$

□

Next, we show that $H_{\beta}^{\varrho}(s, t, q)$ is invariant under VM3 moves.

Proposition 9.3. *Suppose $\beta_1 \in VB_{k+1}$, and $\varrho_1: F_{k+3} \rightarrow GL_n(R)$ is a representation such that $(\beta_1)_* \varrho_1 = \varrho_1$.*

- (i) *If $\beta_2 \in VB_{k+1}$ is related to β_1 by a right virtual exchange move, then we define $\varrho_2: F_{k+3} \rightarrow GL_n(R)$ by setting $\varrho_2(s) = \varrho_1(s)$, $\varrho_2(q) = \varrho_1(q)$, $\varrho_2(x_i) = \varrho_1(x_i)$ for all $1 \leq i \leq k$ and $\varrho_2(qx_{k+1}q^{-1}) = \varrho_1(s^{-1}x_k^{-1}sx_{k+1}x_k)$.*
- (ii) *If $\beta_2 \in VB_{k+1}$ is related to β_1 by a left virtual exchange move, then we define $\varrho_2: F_{k+3} \rightarrow GL_n(R)$ by setting $\varrho_2(s) = \varrho_1(s)$, $\varrho_2(q) = \varrho_1(q)$, $\varrho_2(x_i) = \varrho_1(x_i)$ for all $2 \leq i \leq k+1$ and $\varrho_2(q^{-1}x_1q) = \varrho_1(s^{-1}x_1s)$.*

In either case, we have $(\beta_2)_ \varrho_2 = \varrho_2$ and $H_{\beta_1}^{\varrho_1}(s, t, q) = H_{\beta_2}^{\varrho_2}(s, t, q)$.*

Proof. Let α and β be as in Figure 18. We consider separately the cases of right and left virtual exchange moves.

Right virtual exchange move.

We have $\beta_1 = \alpha \sigma_k \beta \sigma_k^{-1}$ and $\beta_2 = \alpha \tau_k \beta \tau_k$.

Let θ be the automorphism of F_{k+3} given by $s^{\theta} = s$, $q^{\theta} = q$, $x_i^{\theta} = x_i$ for $1 \leq i \leq k$, and $x_{k+1}^{\theta} = q^{-1}s^{-1}x_k^{-1}sx_{k+1}x_kq$. Note that $\theta_* \varrho_1 = \varrho_2$. The assumption that $(\beta_1)_* \varrho_1 = \varrho_1$ is equivalent to ϱ_1 factoring through $\pi_{\beta_1}: F_{k+3} \rightarrow VG_{\beta_1}$ (see the introduction to Section 8 for this notation). The automorphism θ induces an isomorphism $\bar{\theta}: VG_{\beta_2} \rightarrow VG_{\beta_1}$ such that

$$\begin{array}{ccc} F_{k+3} & \xrightarrow{\theta} & F_{k+3} \\ \downarrow \pi_{\beta_2} & & \downarrow \pi_{\beta_1} \\ VG_{\beta_2} & \xrightarrow{\bar{\theta}} & VG_{\beta_1}, \end{array}$$

see Figure 26 for a geometric proof of this fact. The diagram in Figure 26 is obtained as a partial closure of either of the two braids involved in the right exchange move (see Figure 18) after applying $(r2)$ or $(v2)$ of Figure 1, namely the real or virtual Reidemeister two move. It follows that ϱ_2 factors through π_{β_2} and so $(\beta_2)_* \varrho_2 = \varrho_2$.

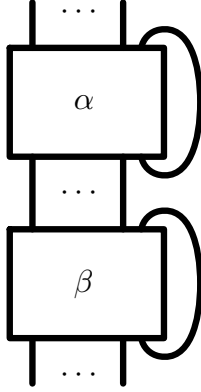

FIGURE 26. The diagram obtained by closing up the two strands on the right in either braid appearing in the right virtual exchange move.

An application of (13) yields

$$(24) \quad \begin{aligned} \Psi_{\varrho_1}(\beta_1) &= \Psi_{(\sigma_k \beta \sigma_k^{-1})_* \varrho_1}(\alpha) \Psi_{(\beta \sigma_k^{-1})_* \varrho_1}(\sigma_k) \Psi_{(\sigma_k^{-1})_* \varrho_1}(\beta) \Psi_{\varrho_1}(\sigma_k^{-1}), \\ \Psi_{\varrho_2}(\beta_2) &= \Psi_{(\tau_k \beta \tau_k)_* \varrho_2}(\alpha) \Psi_{(\beta \tau_k)_* \varrho_2}(\tau_k) \Psi_{(\tau_k)_* \varrho_2}(\beta) \Psi_{\varrho_2}(\tau_k). \end{aligned}$$

Since $\sigma_k \beta \sigma_k^{-1} = \alpha^{-1} \beta_1$ and $(\beta_1)_* \varrho_1 = \varrho_1$, we have $(\sigma_k \beta \sigma_k^{-1})_* \varrho_1 = (\alpha^{-1} \beta_1)_* \varrho_1 = (\alpha^{-1})_* \varrho_1$. Similarly, $(\beta_2)_* \varrho_2 = \varrho_2$ implies $(\tau_k \beta \tau_k)_* \varrho_2 = (\alpha^{-1})_* \varrho_2$. Hence $\Psi_{(\sigma_k \beta \sigma_k^{-1})_* \varrho_1}(\alpha) = \Psi_{(\alpha^{-1})_* \varrho_1}(\alpha)$ and $\Psi_{(\tau_k \beta \tau_k)_* \varrho_2}(\alpha) = \Psi_{(\alpha^{-1})_* \varrho_2}(\alpha)$.

Consider the injective ‘‘right stabilization’’ homomorphism $\mu: F_{k+2} = \langle x_1, \dots, x_k, s, q \rangle \hookrightarrow F_{k+3}$ that takes a generator to a generator of the same name. Since ϱ_1 and ϱ_2 agree on the generators x_j for $1 \leq j \leq k$ we have $\mu_* \varrho_1 = \mu_* \varrho_2$ (where $\mu_* \varrho_j$ denotes the composite of ϱ_j and μ). Let $\varrho = \mu_* \varrho_1$. Note that $\mu_*(\alpha^{-1})_* \varrho_j = (\alpha^{-1})_* \varrho$ for $j = 1, 2$. Let $A = \Psi_{(\alpha^{-1})_* \varrho}(\alpha)$. Then

$$\Psi_{(\sigma_k \beta \sigma_k^{-1})_* \varrho_1}(\alpha) = \begin{bmatrix} A & \mathbf{0} \\ \mathbf{0} & I_n \end{bmatrix} = \Psi_{(\tau_k \beta \tau_k)_* \varrho_2}(\alpha).$$

Call the above matrix A' .

The condition defining ϱ_2 asserts that $(\sigma_k^{-1})_* \varrho_1(x_j) = (\tau_k)_* \varrho_2(x_j)$ for $1 \leq j \leq k$ and so $\mu_*(\sigma_k^{-1})_* \varrho_1 = \mu_*(\tau_k)_* \varrho_2$. Let $\widehat{\varrho} = \mu_*(\sigma_k^{-1})_* \varrho_1$ and let $B = \Psi_{\widehat{\varrho}}(\beta)$. We conclude that

$$\Psi_{(\sigma_k^{-1})_* \varrho_1}(\beta) = \begin{bmatrix} B & \mathbf{0} \\ \mathbf{0} & I_n \end{bmatrix} = \Psi_{(\tau_k)_* \varrho_2}(\beta).$$

Call the above matrix B' .

Let $P' = \Psi_{\varrho_1}(\sigma_k^{-1})$ and $P = \Psi_{(\beta\sigma_k^{-1})_*\varrho_1}(\sigma_k)$. We have $x_k^{\beta\sigma_k^{-1}} = s^{-1}x_k^{-1}sx_{k+1}x_k$ and $x_{k+1}^{\beta\sigma_k^{-1}} = s^{-1}x_k s$, and applying Remark 8.2 shows that P' and P are given by

$$P' = \begin{bmatrix} I_{n(k-1)} & \cdots & \mathbf{0} \\ \vdots & \varrho_1(s^{-1}x_k^{-1}sx_{k+1}) - \varrho_1(s^{-1}x_k^{-1})s^{-1}t^{-1} & \varrho_1(s^{-1}x_k^{-1}s)t^{-1} \\ \mathbf{0} & \varrho_1(s^{-1})s^{-1} & 0 \end{bmatrix},$$

and

$$P = \begin{bmatrix} I_{n(k-1)} & \cdots & \mathbf{0} \\ \vdots & 0 & \varrho_1(s)s \\ \mathbf{0} & \varrho_1(s^{-1}x_k s)t & I_n - \varrho_1(x_{k+1}s)st \end{bmatrix}.$$

Let $Q = \Psi_{\varrho_2}(\tau_k)$. By Remark 8.2, we have $Q = \Psi_{(\beta\tau_k)_*\varrho_2}(\tau_k)$ and so

$$Q = \begin{bmatrix} I_{n(k-1)} & \cdots & \mathbf{0} \\ \vdots & 0 & \varrho_2(q)q \\ \mathbf{0} & \varrho_2(q^{-1})q^{-1} & 0 \end{bmatrix}.$$

With the names given to the various matrices displayed above, we have by (24) that $\Psi_{\varrho_1}(\beta_1) = A'PB'P'$ and $\Psi_{\varrho_2}(\beta_2) = A'QB'Q$. Thus $H_{\beta_1}^{\varrho_1} = \det(A'PB'P' - I_{n(k+1)})$ and $H_{\beta_2}^{\varrho_2} = \det(A'QB'Q - I_{n(k+1)})$.

Let

$$E = \begin{bmatrix} I_{n(k-1)} & \cdots & \mathbf{0} \\ \vdots & I_n & 0 \\ \mathbf{0} & -\varrho_1(x_{k+1})t + \varrho_1(s^{-1})s^{-1} & \varrho_1(s^{-1}x_k s)t \end{bmatrix},$$

$$F_1 = \begin{bmatrix} I_{nk} & \mathbf{0} \\ \mathbf{0} & \varrho_1(s^{-1}x_k s)t \end{bmatrix}, \quad \text{and} \quad F_2 = \begin{bmatrix} I_{nk} & \mathbf{0} \\ \mathbf{0} & \varrho_2(q)q \end{bmatrix}.$$

Consider the matrices

$$M_1 = F_1^{-1} (A'PB'P' - I_{n(k+1)}) E \quad \text{and} \quad M_2 = F_2 (A'QB'Q - I_{n(k+1)}) F_2^{-1}.$$

Since $\det(E) = t^n \det \varrho_1(x_k) = \det(F_1)$, we have $\det(M_1) = H_{\beta_1}^{\varrho_1}$. Also, $\det(M_2) = H_{\beta_2}^{\varrho_2}$.

Claim: $M_1 = M_2$.

Let A_k and B_k denote the k -th block columns of A and B , respectively, and let \widehat{A}_k and \widehat{B}_k be the $nk \times n(k-1)$ matrices obtained by removing the k -th block columns from A and B , respectively.

One then finds that

$$\begin{aligned}
(F_1^{-1}A')P &= \begin{bmatrix} A & \mathbf{0} \\ \mathbf{0} & \varrho_1(s^{-1}x_k^{-1}s)t^{-1} \end{bmatrix} \begin{bmatrix} I_{n-1} & \cdots & \mathbf{0} \\ \vdots & 0 & \varrho_1(s)s \\ \mathbf{0} & \varrho_1(s^{-1}x_k s)t & I_n - \varrho_1(x_{k+1}s)st \end{bmatrix} \\
&= \begin{bmatrix} \widehat{A}_k & \mathbf{0} & A_k\varrho_1(s)s \\ \mathbf{0} & I_n & \varrho_1(s^{-1}x_k^{-1}s)t^{-1} - \varrho_1(s^{-1}x_k^{-1}sx_{k+1}s)s \end{bmatrix} \quad \text{and} \\
B'(P'E) &= \begin{bmatrix} B & \mathbf{0} \\ \mathbf{0} & I_n \end{bmatrix} \begin{bmatrix} I_{n(k-1)} & \cdots & \mathbf{0} \\ \vdots & 0 & I_n \\ \mathbf{0} & \varrho_1(s^{-1})s^{-1} & 0 \end{bmatrix} = \begin{bmatrix} \widehat{B}_k & \mathbf{0} & B_k \\ \mathbf{0} & \varrho_1(s^{-1})s^{-1} & 0 \end{bmatrix}.
\end{aligned}$$

Furthermore, we have

$$\begin{aligned}
F_1^{-1}E &= \begin{bmatrix} I_{nk} & \mathbf{0} \\ \mathbf{0} & \varrho_1(s^{-1}x_k^{-1}s)t^{-1} \end{bmatrix} \begin{bmatrix} I_{n(k-1)} & \cdots & \mathbf{0} \\ \vdots & I_n & 0 \\ \mathbf{0} & -\varrho_1(x_{k+1})t + \varrho_1(s^{-1})s^{-1} & \varrho_1(s^{-1}x_k s)t \end{bmatrix} \\
&= \begin{bmatrix} I_{n(k-1)} & \cdots & \mathbf{0} \\ \vdots & I_n & 0 \\ \mathbf{0} & \varrho_1(s^{-1}x_k^{-1})s^{-1}t^{-1} - \varrho_1(s^{-1}x_k^{-1}sx_{k+1}) & I_n \end{bmatrix}.
\end{aligned}$$

It follows that

$$\begin{aligned}
(25) \quad M_1 &= (F_1^{-1}A'P)(B'P'E) - F_1^{-1}E \\
&= \begin{bmatrix} \widehat{A}_k & 0 & A_k\varrho_1(s)s \\ \mathbf{0} & I_n & \varrho_1(s^{-1}x_k^{-1}s)t^{-1} - \varrho_1(s^{-1}x_k^{-1}sx_{k+1}s)s \end{bmatrix} \begin{bmatrix} \widehat{B}_k & 0 & B_k \\ \mathbf{0} & \varrho_1(s^{-1})s^{-1} & 0 \end{bmatrix} \\
&\quad - \begin{bmatrix} I_{n(k-1)} & \cdots & \mathbf{0} \\ \vdots & I_n & 0 \\ \mathbf{0} & \varrho_1(s^{-1}x_k^{-1})s^{-1}t^{-1} - \varrho_1(s^{-1}x_k^{-1}sx_{k+1}) & I_n \end{bmatrix}.
\end{aligned}$$

An easy computation shows that

$$\begin{aligned}
(F_2A')Q &= \begin{bmatrix} A & \mathbf{0} \\ \mathbf{0} & \varrho_2(q)q \end{bmatrix} \begin{bmatrix} I_{n(k-1)} & \cdots & \mathbf{0} \\ \vdots & 0 & \varrho_2(q)q \\ \mathbf{0} & \varrho_2(q^{-1})q^{-1} & 0 \end{bmatrix} = \begin{bmatrix} \widehat{A}_k & \mathbf{0} & A_k\varrho_2(q)q \\ \mathbf{0} & I_n & 0 \end{bmatrix} \quad \text{and} \\
B'(QF_2^{-1}) &= \begin{bmatrix} B & \mathbf{0} \\ \mathbf{0} & I_n \end{bmatrix} \begin{bmatrix} I_{n(k-1)} & \cdots & \mathbf{0} \\ \vdots & 0 & I_n \\ \mathbf{0} & \varrho_2(q^{-1})q^{-1} & 0 \end{bmatrix} = \begin{bmatrix} \widehat{B}_k & \mathbf{0} & B_k \\ \mathbf{0} & \varrho_2(q^{-1})q^{-1} & 0 \end{bmatrix}.
\end{aligned}$$

Thus, we find that

$$(26) \quad \begin{aligned} M_2 &= (F_2 A' Q) (B' Q F_2^{-1}) - I_{n(k+1)} \\ &= \begin{bmatrix} \widehat{A}_k & \mathbf{0} & A_k \varrho_2(q)q \\ \mathbf{0} & I_n & 0 \end{bmatrix} \begin{bmatrix} \widehat{B}_k & \mathbf{0} & B_k \\ \mathbf{0} & \varrho_2(q^{-1})q^{-1} & 0 \end{bmatrix} - I_{n(k+1)}. \end{aligned}$$

The claim now follows by direct comparison of Equations (25) and (26), showing that

$$H_{\beta_1}^{\varrho_1} = \det(M_1) = \det(M_2) = H_{\beta_2}^{\varrho_2}.$$

Left virtual exchange move.

We have $\beta_1 = \alpha \sigma_1 \beta \sigma_1^{-1}$ and $\beta_2 = \alpha \tau_1 \beta \tau_1$. As in the case of the right virtual exchange move, $(\beta_2)_* \varrho_2 = \varrho_2$.

Applying (13), it follows that

$$(27) \quad \begin{aligned} \Psi_{\varrho_1}(\beta_1) &= \Psi_{(\sigma_1 \beta \sigma_1^{-1})_* \varrho_1}(\alpha) \Psi_{(\beta \sigma_1^{-1})_* \varrho_1}(\sigma_1) \Psi_{(\sigma_1^{-1})_* \varrho_1}(\beta) \Psi_{\varrho_1}(\sigma_1^{-1}), \\ \Psi_{\varrho_2}(\beta_2) &= \Psi_{(\tau_1 \beta \tau_1)_* \varrho_2}(\alpha) \Psi_{(\beta \tau_1)_* \varrho_2}(\tau_1) \Psi_{(\tau_1)_* \varrho_2}(\beta) \Psi_{\varrho_2}(\tau_1). \end{aligned}$$

Since $\sigma_1 \beta \sigma_1^{-1} = \alpha^{-1} \beta_1$ and $(\beta_1)_* \varrho_1 = \varrho_1$, we have $(\sigma_1 \beta \sigma_1^{-1})_* \varrho_1 = (\alpha^{-1} \beta_1)_* \varrho_1 = (\alpha^{-1})_* \varrho_1$. Similarly, $(\beta_2)_* \varrho_2 = \varrho_2$ implies $(\tau_1 \beta \tau_1)_* \varrho_2 = (\alpha^{-1})_* \varrho_2$. Hence $\Psi_{(\sigma_1 \beta \sigma_1^{-1})_* \varrho_1}(\alpha) = \Psi_{(\alpha^{-1})_* \varrho_1}(\alpha)$ and $\Psi_{(\tau_1 \beta \tau_1)_* \varrho_2}(\alpha) = \Psi_{(\alpha^{-1})_* \varrho_2}(\alpha)$.

Consider the injective ‘‘left stabilization’’ homomorphism $\mu: F'_{k+2} = \langle x_2, \dots, x_{k+1}, s, q \rangle \hookrightarrow F_{k+3}$ that takes a generator to a generator of the same name. Since ϱ_1 and ϱ_2 agree on the generators x_j for $2 \leq j \leq k+1$ we have $\mu_* \varrho_1 = \mu_* \varrho_2$ (where $\mu_* \varrho_j$ denotes the composite of ϱ_j and μ). Let $\varrho = \mu_* \varrho_1$. Note that $\mu_*(\alpha^{-1})_* \varrho_j = (\alpha^{-1})_* \varrho$ for $j = 1, 2$. Let $A = \Psi_{(\alpha^{-1})_* \varrho}(\alpha)$. Then

$$\Psi_{(\sigma_1 \beta \sigma_1^{-1})_* \varrho_1}(\alpha) = \begin{bmatrix} I_n & \mathbf{0} \\ \mathbf{0} & A \end{bmatrix} = \Psi_{(\tau_1 \beta \tau_1)_* \varrho_2}(\alpha).$$

Call the above matrix A' .

The condition defining ϱ_2 asserts that $(\sigma_1^{-1})_* \varrho_1(x_j) = (\tau_1)_* \varrho_2(x_j)$ for $2 \leq j \leq k+1$ and so $\mu_*(\sigma_1^{-1})_* \varrho_1 = \mu_*(\tau_1)_* \varrho_2$. Let $\widehat{\varrho} = \mu_*(\sigma_1^{-1})_* \varrho_1$ and let $B = \Psi_{\widehat{\varrho}}(\beta)$. We conclude that

$$\Psi_{(\sigma_1^{-1})_* \varrho_1}(\beta) = \begin{bmatrix} I_n & \mathbf{0} \\ \mathbf{0} & B \end{bmatrix} = \Psi_{(\tau_1)_* \varrho_2}(\beta).$$

Call the above matrix B' .

Let $P' = \Psi_{\varrho_1}(\sigma_1^{-1})$ and $P = \Psi_{(\beta\sigma_1^{-1})_{*\varrho_1}}(\sigma_1)$. We have $x_1^{\beta\sigma_1^{-1}} = s^{-1}x_1^{-1}sx_2x_1$ and $x_2^{\beta\sigma_1^{-1}} = s^{-1}x_1s$, and applying Remark 8.2 shows that P' and P are given by

$$P' = \begin{bmatrix} \varrho_1(s^{-1}x_1^{-1}sx_2) - \varrho_1(s^{-1}x_1^{-1})s^{-1}t^{-1} & \varrho_1(s^{-1}x_1^{-1}s)t^{-1} & \mathbf{0} \\ \varrho_1(s^{-1})s^{-1} & 0 & \vdots \\ \mathbf{0} & \cdots & I_{n(k-1)} \end{bmatrix},$$

and

$$P = \begin{bmatrix} 0 & \varrho_1(s)s & \mathbf{0} \\ \varrho_1(s^{-1}x_1s)t & I_n - \varrho_1(x_2s)st & \vdots \\ \mathbf{0} & \cdots & I_{n(k-1)} \end{bmatrix}.$$

Let $Q = \Psi_{\varrho_2}(\tau_1)$. By Remark 8.2, we have $Q = \Psi_{(\beta\tau_1)_{*\varrho_2}}(\tau_1)$ and so

$$Q = \begin{bmatrix} 0 & \varrho_2(q)q & \mathbf{0} \\ \varrho_2(q^{-1})q^{-1} & 0 & \vdots \\ \mathbf{0} & \cdots & I_{n(k-1)} \end{bmatrix}.$$

With the names given to the various matrices displayed above, we have by (27) that $\Psi_{\varrho_1}(\beta_1) = A'PB'P'$ and $\Psi_{\varrho_2}(\beta_2) = A'QB'Q$.

Let

$$E = \begin{bmatrix} \varrho_1(s^{-1}x_1^{-1}s)t^{-1} & \varrho_1(s^{-1}x_1^{-1}sx_2s)s - \varrho_1(s^{-1}x_1^{-1}s)t^{-1} & \mathbf{0} \\ 0 & I_n & \vdots \\ \mathbf{0} & \cdots & I_{n(k-1)} \end{bmatrix},$$

$$F_1 = \begin{bmatrix} \varrho_1(s^{-1}x_1s)t & \mathbf{0} \\ \mathbf{0} & I_{nk} \end{bmatrix}, \quad \text{and} \quad F_2 = \begin{bmatrix} \varrho_2(q)q & \mathbf{0} \\ \mathbf{0} & I_{nk} \end{bmatrix}.$$

Since $\beta_1 = \alpha\sigma_1\beta\sigma_1^{-1}$ and $\beta_2 = \alpha\tau_1\beta\tau_1$, we have

$$\begin{aligned} H_{\beta_1}^{\varrho_1} &= \det(A'PB'P' - I_{n(k+1)}) = \det(B'P'A'P - I_{n(k+1)}) \quad \text{and} \\ H_{\beta_2}^{\varrho_2} &= \det(A'QB'Q - I_{n(k+1)}) = \det(B'QA'Q - I_{n(k+1)}). \end{aligned}$$

Consider the matrices

$$M_1 = F_1(B'P'A'P - I_{n(k+1)})E \quad \text{and} \quad M_2 = F_2^{-1}(B'QA'Q - I_{n(k+1)})F_2.$$

Since $\det(E) = t^{-n} \det \varrho_1(x_2)^{-1}$ and $\det(F_1) = t^n \det \varrho_1(x_2)$, we have $\det(M_1) = H_{\beta_1}^{\varrho_1}$. Also, $\det(M_2) = H_{\beta_2}^{\varrho_2}$.

Claim: $M_1 = M_2$.

Let A_1 and B_1 denote the first block columns of A and B , respectively, and let \widehat{A}_1 and \widehat{B}_1 be the $nk \times n(k-1)$ matrices obtained by removing the first block columns from A and B , respectively.

One then finds that

$$\begin{aligned}
(F_1 B') P' &= \begin{bmatrix} \varrho_1(s^{-1}x_1s)t & \mathbf{0} \\ \mathbf{0} & B \end{bmatrix} \begin{bmatrix} \varrho_1(s^{-1}x_1^{-1}sx_2) - \varrho_1(s^{-1}x_1^{-1})s^{-1}t^{-1} & \varrho_1(s^{-1}x_1^{-1}s)t^{-1} & \mathbf{0} \\ & \varrho_1(s^{-1})s^{-1} & 0 \\ & \mathbf{0} & \cdots & I_{n(k-1)} \end{bmatrix} \\
&= \begin{bmatrix} \varrho_1(x_2)t - \varrho_1(s^{-1})s^{-1} & I_n & \mathbf{0} \\ B_1\varrho_1(s^{-1})s^{-1} & \mathbf{0} & \widehat{B}_1 \end{bmatrix} \quad \text{and} \\
A'(PE) &= \begin{bmatrix} I_n & \mathbf{0} \\ \mathbf{0} & A \end{bmatrix} \begin{bmatrix} 0 & \varrho_1(s)s & \mathbf{0} \\ I_n & 0 & \vdots \\ \mathbf{0} & \cdots & I_{n(k-1)} \end{bmatrix} = \begin{bmatrix} 0 & \varrho_1(s)s & \mathbf{0} \\ A_1 & \mathbf{0} & \widehat{A}_1 \end{bmatrix}.
\end{aligned}$$

Furthermore, we have

$$\begin{aligned}
F_1 E &= \begin{bmatrix} \varrho_1(s^{-1}x_1s)t & \mathbf{0} \\ \mathbf{0} & I_{nk} \end{bmatrix} \begin{bmatrix} \varrho_1(s^{-1}x_1^{-1}s)t^{-1} & \varrho_1(s^{-1}x_1^{-1}sx_2s) - \varrho_1(s^{-1}x_1^{-1})s^{-1}t^{-1} & \mathbf{0} \\ & 0 & I_n \\ & \mathbf{0} & \cdots & I_{n(k-1)} \end{bmatrix} \\
&= \begin{bmatrix} I_n & \varrho_1(x_2s)st - I_n & \mathbf{0} \\ 0 & I_n & \vdots \\ \mathbf{0} & \cdots & I_{n(k-1)} \end{bmatrix}.
\end{aligned}$$

It follows that

$$\begin{aligned}
(28) \quad M_1 &= (F_1 B' P') (A' P E) - F_1 E \\
&= \begin{bmatrix} \varrho_1(x_2)t - \varrho_1(s^{-1})s^{-1} & I_n & \mathbf{0} \\ B_1\varrho_1(s^{-1})s^{-1} & 0 & \widehat{B}_1 \end{bmatrix} \begin{bmatrix} 0 & \varrho_1(s)s & \mathbf{0} \\ A_1 & 0 & \widehat{A}_1 \end{bmatrix} \\
&\quad - \begin{bmatrix} I_n & \varrho_1(x_2s)st - I_n & \mathbf{0} \\ 0 & I_n & \vdots \\ \mathbf{0} & \cdots & I_{n(k-1)} \end{bmatrix}.
\end{aligned}$$

An easy computation shows that

$$\begin{aligned}
(F_2^{-1} B') Q &= \begin{bmatrix} \varrho_2(q^{-1})q^{-1} & \mathbf{0} \\ \mathbf{0} & B \end{bmatrix} \begin{bmatrix} 0 & \varrho_2(q)q & \mathbf{0} \\ \varrho_2(q^{-1})q^{-1} & 0 & \vdots \\ \mathbf{0} & \cdots & I_{n(k-1)} \end{bmatrix} = \begin{bmatrix} 0 & I_n & \mathbf{0} \\ B_1\varrho_2(q^{-1})q^{-1} & \mathbf{0} & \widehat{B}_1 \end{bmatrix} \quad \text{and} \\
A'(QF_2) &= \begin{bmatrix} I_n & \mathbf{0} \\ \mathbf{0} & A \end{bmatrix} \begin{bmatrix} 0 & \varrho_2(q)q & \mathbf{0} \\ I_n & 0 & \vdots \\ \mathbf{0} & \cdots & I_{n(k-1)} \end{bmatrix} = \begin{bmatrix} 0 & \varrho_2(q)q & \mathbf{0} \\ A_1 & \mathbf{0} & \widehat{A}_1 \end{bmatrix}.
\end{aligned}$$

Thus, we find that

$$(29) \quad \begin{aligned} M_2 &= (F_2^{-1}B'Q)(A'QF_2) - I_{n(k+1)} \\ &= \begin{bmatrix} 0 & I_n & \mathbf{0} \\ B_1\varrho_2(q^{-1})q^{-1} & \mathbf{0} & \widehat{B}_1 \end{bmatrix} \begin{bmatrix} 0 & \varrho_2(q)q & \mathbf{0} \\ A_1 & \mathbf{0} & \widehat{A}_1 \end{bmatrix} - I_{n(k+1)}. \end{aligned}$$

The claim now follows by direct comparison of Equations (28) and (29), showing that

$$H_{\beta_1}^{\varrho_1} = \det(M_1) = \det(M_2) = H_{\beta_2}^{\varrho_2}.$$

□

We apply these results to define a preferred normalization for the twisted virtual Alexander polynomial $H_K^{\varrho}(s, t, q)$ as follows. Let K be a virtual knot or link represented as the closure of a braid $\beta \in VB_k$, and suppose $\varrho: F_{k+2} \rightarrow GL_n(R)$ is a representation such that $\beta_*\varrho = \varrho$.

Definition 9.4. The *normalized twisted virtual Alexander polynomial* is given by setting

$$\widehat{H}_K^{\varrho}(s, t, q) = (-1)^{n(wr(\beta)+v(\beta))} H_{\beta}^{\varrho}(s, t, q),$$

where $wr(\beta)$ is the writhe and $v(\beta)$ is the virtual crossing number of $\widehat{\beta}$. Then $\widehat{H}_K^{\varrho}(s, t, q)$ is an invariant of virtual knots and links that is well-defined up to a factor of $\varepsilon(st)^{jn}$, where ε is a unit in R and $j \in \mathbb{Z}$. In fact, one can further assume ε lies in the image of $\det \varrho(F_{k+2}) \subset R$, so if $\varrho: F_{k+2} \rightarrow SL_n(R)$ is unimodular, then $\widehat{H}_K^{\varrho}(s, t, q)$ is well-defined up to $(st)^{jn}$.

Invariance follows from Theorem 5.1, Proposition 9.2 and Proposition 9.3, which show that $(-1)^{n(wr(\beta)+v(\beta))} H_{\beta}^{\varrho}(s, t, q)$ is independent of the braid representative, up to an overall factor of $\varepsilon(st)^{jn}$. We will write $\widehat{H}_K^{\varrho}(s, t, q) = f$ whenever $f \in \mathcal{L}$ is a Laurent polynomial such that $\widehat{H}_K(s, t, q) = \varepsilon(st)^{jn} \cdot f$ for ε a unit in R and $j \in \mathbb{Z}$.

Using the normalized twisted virtual Alexander polynomial, we obtain the following improvement of Theorem 7.8. Recall that $\deg_{q^{-1}}$ and \deg_q are defined for the Laurent polynomial $\widehat{H}_K^{\varrho}(s, t, q)$ by regarding it as a polynomial in q and q^{-1} .

Theorem 9.5. *Given a virtual knot or link K , then*

$$\deg_{q^{-1}} \widehat{H}_K^{\varrho}(s, t, q) \leq n v(K) \quad \text{and} \quad \deg_q \widehat{H}_K^{\varrho}(s, t, q) \leq n v(K).$$

Concluding Remarks. In the classical case, twisted Alexander invariants have been used to characterize fibered knots [11], to study sliceness [26, 15] and periodicity [16], and to understand a partial ordering on knots defined in terms of surjections between the associated knot groups [30, 29, 17]. It would be interesting to develop similar results for virtual knots, though it is not at all obvious how to define fibered and slice knots in the virtual category. On the other hand, there is a well-developed notion of periodicity for virtual knots, and it is expected that the Alexander invariants and twisted Alexander invariants will take a special form for periodic virtual knots. Further, just as in the classical case, one can construct a partial ordering on virtual knots in terms of surjections of the virtual knot groups, and

the twisted Alexander invariants can be applied to those questions by the general results of Kitano, Suzuki, and Wada in [30].

For classical knots, the knot group G_K has a topological interpretation as the fundamental group of the complement of the knot, and a natural question to ask is whether the virtual knot group VG_K is the fundamental group of some topological space naturally associated to K . A related problem is to characterize which groups occur as virtual knot groups VG_K for a virtual knot K , and we note that the corresponding problem for the knot group G_K was solved by Kim in [25]. It would be interesting to develop the theory of virtual knot groups and Alexander invariants for virtual tangles and for long virtual knots. It would also be interesting to construct a categorification of the virtual Alexander polynomial $H_K(s, t, q)$. Finally, while the focus of this paper has been on the case of virtual knots, one can establish similar results for virtual links using multi-variable Alexander polynomials. We hope to explore some of these questions in future work.

Acknowledgements. H. Boden and A. Nicas were supported by grants from the Natural Sciences and Engineering Research Council of Canada. E. Dies, A. Gaudreau and A. Gerlings were supported by Undergraduate Student Research Awards from the Natural Sciences and Engineering Research Council of Canada.

REFERENCES

- [1] I. Agol, *Criteria for virtual fibering*, J. Topol. **1** (2008), no. 2, 269–284. MR 2399130 (2009b:57033)
- [2] V. G. Bardakov and P. Bellingeri, *Groups of virtual and welded links*, J. Knot Theory Ramifications **23** (2014), no. 3, 1450014 (23 pages). MR 3200494
- [3] A. Bartholomew and R. Fenn, *Quaternionic invariants of virtual knots and links*, J. Knot Theory Ramifications **17** (2008), no. 2, 231–251. MR 2398735 (2009b:57006)
- [4] K. Bhandari, H. A. Dye, and L. H. Kauffman, *Lower bounds on virtual crossing number and minimal surface genus*, The mathematics of knots, Contrib. Math. Comput. Sci., vol. 1, Springer, Heidelberg, 2011, pp. 31–43. MR 2777846 (2012g:57011)
- [5] J. S. Carter, S. Kamada, and M. Saito, *Stable equivalence of knots on surfaces and virtual knot cobordisms*, J. Knot Theory Ramifications **11** (2002), no. 3, 311–322, Knots 2000 Korea, Vol. 1 (Yongpyong). MR 1905687 (2003f:57011)
- [6] A. S. Crans, A. Henrich, and S. Nelson, *Polynomial knot and link invariants from the virtual biquandle*, J. Knot Theory Ramifications **22** (2013), no. 4, 1340004.
- [7] R. H. Crowell, and R. H. Fox, Introduction to knot theory. Reprint of the 1963 original. GTM **57**. Springer-Verlag, 1977. MR 0445489 (56 #3829)
- [8] H. A. Dye and L. H. Kauffman, *Virtual crossing number and the arrow polynomial*, J. Knot Theory Ramifications **18** (2009), no. 10, 1335–1357. MR 2583800 (2010m:57011)
- [9] Roger Fenn, Louis H. Kauffman, and Vassily O. Manturov, *Virtual knot theory—unsolved problems*, Fund. Math. **188** (2005), 293–323. MR 2191949 (2006k:57011)
- [10] R. H. Fox, *Free differential calculus. I. Derivation in the free group ring*, Ann. of Math. (2) **57** (1953), 547–560. MR 0053938 (14,843d)
- [11] S. Friedl and S. Vidussi, *Twisted Alexander polynomials detect fibered 3-manifolds*, Ann. of Math. (2) **173** (2011), no. 3, 1587–1643. MR 2800721 (2012f:57025)
- [12] ———, *Twisted Alexander polynomials detect trivial links*, 2013, [arXiv:1306.3487](https://arxiv.org/abs/1306.3487).
- [13] M. Goussarov, M. Polyak, and O. Viro, *Finite-type invariants of classical and virtual knots*, Topology **39** (2000), no. 5, 1045–1068. MR 1763963 (2001i:57017)
- [14] J. Green, *A table of virtual knots*, 2004, www.math.toronto.edu/drorbn/Students/GreenJ/.

- [15] C. Herald, P. Kirk, and C. Livingston, *Metabelian representations, twisted Alexander polynomials, knot slicing, and mutation*, Math. Z. **265** (2010), no. 4, 925–949. MR 2652542 (2011g:57006)
- [16] J. A. Hillman, C. Livingston, and S. Naik, *Twisted Alexander polynomials of periodic knots*, Algebr. Geom. Topol. **6** (2006), 145–169 (electronic). MR 2199457 (2006m:57006)
- [17] K. Horie, T. Kitano, M. Matsumoto, and M. Suzuki, *A partial order on the set of prime knots with up to 11 crossings*, J. Knot Theory Ramifications **20** (2011), no. 2, 275–303. MR 2782704 (2012h:57011)
- [18] S. Kamada, *Invariants of virtual braids and a remark on left stabilizations and virtual exchange moves*, Kobe J. Math. **21** (2004), no. 1-2, 33–49. MR 2140600 (2006d:57019)
- [19] ———, *Braid presentation of virtual knots and welded knots*, Osaka J. Math. **44** (2007), no. 2, 441–458. MR 2351010 (2008k:57013)
- [20] S. Kamada and N. Kamada, *Abstract link diagrams and virtual knots*, J. Knot Theory Ramifications **9** (2000), no. 1, 93–106. MR MR1749502 (2001h:57007)
- [21] T. Kanenobu, *Forbidden moves unknot a virtual knot*, J. Knot Theory Ramifications **10** (2001), no. 1, 89–96. MR 1822142 (2002c:57006)
- [22] L. Kauffman and S. Lambropoulou, *The L-move and virtual braids*, Intelligence of low dimensional topology 2006, Ser. Knots Everything, vol. 40, World Sci. Publ., Hackensack, NJ, 2007, pp. 133–142. MR 2371718 (2008m:57014)
- [23] L. H. Kauffman, *Virtual knot theory*, European J. Combin. **20** (1999), no. 7, 663–690. MR 1721925 (2000i:57011)
- [24] L. H. Kauffman and D. Radford, *Bi-oriented quantum algebras, and a generalized Alexander polynomial for virtual links*, Diagrammatic morphisms and applications (San Francisco, CA, 2000), Contemp. Math., vol. 318, Amer. Math. Soc., Providence, RI, 2003, pp. 113–140. MR 1973514 (2004c:57013)
- [25] S. G. Kim, *Virtual knot groups and their peripheral structure*, J. Knot Theory Ramifications **9** (2000) no. 6, 797–812.
- [26] P. Kirk and C. Livingston, *Twisted Alexander invariants, Reidemeister torsion, and Casson-Gordon invariants*, Topology **38** (1999), no. 3, 635–661. MR 1670420 (2000c:57010)
- [27] T. Kishino and S. Satoh, *A note on non-classical virtual knots*, J. Knot Theory Ramifications **13** (2004), no. 7, 845–856. MR 2101229 (2005g:57018)
- [28] T. Kitano and T. Morifuji, *Divisibility of twisted Alexander polynomials and fibered knots*, Ann. Sc. Norm. Super. Pisa Cl. Sci. (5) **4** (2005), no. 1, 179–186. MR 2165406 (2006e:57006)
- [29] T. Kitano and M. Suzuki, *A partial order in the knot table*, Experiment. Math. **14** (2005), no. 4, 385–390. MR 2193401 (2006k:57018)
- [30] T. Kitano, M. Suzuki, and M. Wada, *Twisted Alexander polynomials and surjectivity of a group homomorphism*, Algebr. Geom. Topol. **5** (2005), 1315–1324. MR 2171811 (2006j:57016)
- [31] G. Kuperberg, *What is a virtual link?*, Algebr. Geom. Topol. **3** (2003), 587–591 (electronic). MR 1997331 (2004f:57012)
- [32] X. S. Lin, *Representations of knot groups and twisted Alexander polynomials*, Acta Math. Sin. (Engl. Ser.) **17** (2001), no. 3, 361–380. MR 1852950 (2003f:57018)
- [33] V. O. Manturov, *On invariants of virtual links*, Acta Appl. Math. **72** (2002), no. 3, 295–309. MR 1916950 (2004d:57010)
- [34] V. O. Manturov and D. P. Ilyutko, *Virtual knots*, Series on Knots and Everything, vol. 51, World Scientific Publishing Co. Pte. Ltd., Hackensack, NJ, 2013, The state of the art, Translated from the 2010 Russian original, With a preface by Louis H. Kauffman. MR 2986036
- [35] S. Nelson, *Unknotting virtual knots with Gauss diagram forbidden moves*, J. Knot Theory Ramifications **10** (2001), no. 6, 931–935. MR 1840276 (2002c:57009)
- [36] D. G. Northcott, *Finite free resolutions*, Cambridge University Press, Cambridge-New York-Melbourne, 1976, Cambridge Tracts in Mathematics, No. 71. MR 0460383 (57 #377)
- [37] T. Okabayashi, *Forbidden moves for virtual links*, Kobe J. Math., **22** (2005) 49–63. MR 2203330 (2006i:57016)
- [38] C. Rourke, *What is a welded link?*, Intelligence of low dimensional topology 2006, Ser. Knots Everything, vol. 40, World Sci. Publ., Hackensack, NJ, 2007, pp. 263–270. MR 2371734 (2008m:57021)

- [39] S. Satoh, *Virtual knot presentation of ribbon torus-knots*, J. Knot Theory Ramifications **9** (2000), no. 4, 531–542. MR 1758871 (2001c:57029)
- [40] J. Sawollek, *On Alexander-Conway polynomials for virtual knots and links*, 1999 (revised 2001), [arXiv:math.GT/9912173](https://arxiv.org/abs/math/9912173)
- [41] D. S. Silver and S. G. Williams, *Virtual knot groups*, Knots in Hellas 98, World Scientific 2000, 440–451. MR 1865722 (2002m:57011)
- [42] ———, *Alexander groups and virtual links*, J. Knot Theory Ramifications **10** (2001), no. 1, 151–160. MR 1822148 (2002b:57014)
- [43] ———, *Polynomial invariants of virtual links*, J. Knot Theory Ramifications, **12** (2003), no. 7, 987–1000. MR 2017967 (2004i:57015)
- [44] ———, *Crowell’s derived group and twisted polynomials*, J. Knot Theory Ramifications **15** (2006), no. 8, 1079–1094. MR 2275098 (2008i:57011)
- [45] ———, *Twisted Alexander polynomials detect the unknot*, Algebr. Geom. Topol. **6** (2006), 1893–1901 (electronic). MR 2263053 (2007g:57015)
- [46] W. A. Stein et al., *Sage Mathematics Software (Version 5.9)*, The Sage Development Team, 2014, www.sagemath.org.
- [47] M. Wada, *Twisted Alexander polynomial for finitely presentable groups*, Topology **33** (1994), no. 2, 241–256. MR 1273784 (95g:57021)

MATHEMATICS & STATISTICS, MCMASTER UNIVERSITY, HAMILTON, ONTARIO

E-mail address: boden@mcmaster.ca

MATHEMATICS & STATISTICS, MCMASTER UNIVERSITY, HAMILTON, ONTARIO

E-mail address: diesej@mcmaster.ca

MATHEMATICS & STATISTICS, MCMASTER UNIVERSITY, HAMILTON, ONTARIO

E-mail address: gaudreai@mcmaster.ca

MATHEMATICS & STATISTICS, UNIVERSITY OF CALGARY, CALGARY, ALBERTA

E-mail address: agerling@ucalgary.ca

MATHEMATICS & STATISTICS, MCMASTER UNIVERSITY, HAMILTON, ONTARIO

E-mail address: eharper@math.mcmaster.ca

MATHEMATICS & STATISTICS, MCMASTER UNIVERSITY, HAMILTON, ONTARIO

E-mail address: nicas@mcmaster.ca